

Lampiran 1

072.423.4.07.00



UNIVERSITAS
MERCU BUANA

KARTU ASISTENSI FAKULTAS TEKNIK

NAMA : Diana Octavia
NIM : 41219120009
FAK/JUR : TEKNIK ARSITEKTUR
MATA KULIAH : Praktik Profesi
SMT/THN.AKAD : SP1 8
DOSEN : Ir. Andjar-Wichajanti, MT

NO.	TGL	KETERANGAN	PARAF	NO.	TGL	KETERANGAN	PARAF
1.	10/18	1. Rangkuman di bab 1 2. bangunanya sudah jadi atau belum apa masih proses		2.	26/18	Baba tentang Proses selama magang di konsultan. (proses kan proy)	
		3. atau bangunanya sudah jadi dan menggambar ulang (as builang)				Proyek yang dijadikan judul	
		4. Organisasi konsultan dan kualifikasi konsultan di ban 2.		3.	*	Bab 1 Lingkup Pekerjaan / Pembahasan	
		5. Bab 3 konsultan pernah mengerjakan apa saja (uraikan)			*	harus nyambung dengan Bab 4. Metode harus sesuai +	
		(konsultan) di kaitkan dengan proyek yang untuk di lakukan		3.	2/19	1. proses gambar di jelaskan di bagian deskripsi	
		di Bab halaman terakhir				2. Finis dari proses gambar baru dilampirkan gambar yang besarnya	
		Bab 3 proyek yang sedang di kerjakan				3. Project yang di uraikan proyek yang dijadikan judul saja	
		6. Bab tentang proyek yang sedang di kerjakan prosesnya di lampirkan. dan yang sudah jadi gambar finisnya				4. Tapi apabila ingin semua yang dikerjakan di kaitkan maka judulnya diganti Nama Biro konsultan.	
		di kempirkan di lampiran		4.	1/19	Lanjut Bab 5 Teruskan deskripsi yang dikerjakan proyeknya.	
2.	26/18	1. Bab 2 menjelaskan tentang konsultan (PROFIL Perusahaan) saja.				Lanjutkan!	
		2. Tidak Perlu ada subkontraktor atau MK					
		3. Bab 3 baru tentang proyek yang sedang dikerjakan di tempat konsultan dan yang jadi judul laporan					

Lampiran 2

KARTU ASISTENSI FAKULTAS TEKNIK

NO.	TGL	KETERANGAN	PARAF	NO.	TGL	KETERANGAN	PARAF
5.	04/02	Rapikan kembali Lampirannya. Lanjut Hard cover.					

UNIVERSITAS
MERCU BUANA

Lampiran 3

TRENDRAMA
architect
Rukan Puri Mutira Blok. A/126, Sunter Griya – Jakarta Utara – 14350
Phone. 62 – 21 – 65310617
Fax. 62 – 21 – 65310618
Email trendrama@yahoo.com

Jakarta, 2 Februari 2019

Kepada Yth,
Ketua Program Studi Teknik Arsitektur
Fakultas Teknik
Universitas Mercu Buana

Perihal : Hasil Evaluasi Praktik Profesi

Setelah mempelajari serta mempertimbangkan aktivitas praktik profesi bagi mahasiswa tersebut di bawah ini :

Nama : Dian Octavia
NIM : 41214120004
Program Studi : Teknik Arsitektur
Lembaga/Perusahaan : Konsultan Arsitek
Lama Magang : 03 Sept 2018 – 31 Des 2018

Berikut ini kami sampaikan hasil evaluasinya :

Penilaian	Nilai Angka (NA)	Bobot (B)	NAxB	Konversi Nilai
Kehadiran	90	15%	13,5	80 – 100 = A 74 - < 80 = B+ 68 - < 74 = B 62 - < 68 = C+ 56 - < 62 = C 46 - < 56 = D 0 - < 46 = E
Kedisiplinan	90	15%	13,5	
Keseriusan & Motivasi Kerja	80	15%	12	
Penguasaan Materi Kerja	80	30%	24	
Kemampuan Beradaptasi & Bekerjasama	80	15%	12	
Presentasi	80	10%	8	
		Total Nilai	83	

Evaluasi ini merupakan evaluasi kepada praktikan selama mengikuti praktik profesi pada lembaga/perusahaan kami.

Hormat kami,

TRENDRAMA
architect
ANGELINA ROSALIND. J
(Pembimbing Lapangan)

Lampiran 4

	FORM PENILAIAN PRAKTIK PROFESI PROGRAM STUDI TEKNIK ARSITEKTUR	Q
	No. Dokumen : 061.423.4.70.00 Tanggal Efektif : 01 September 2013	

Jakarta, 4 / Febuari / 2019
Kepada Yth,
Koordinator Praktik Profesi
Program Studi Teknik Arsitektur
di Tempat,

Perihal : Hasil Evaluasi Praktik Profesi

Dengan Hormat,
Setelah menyelesaikan seluruh proses kegiatan magang dan penyusunan laporan Praktik Profesi dari mahasiswa berikut ini, maka dengan ini kami sampaikan hasil evaluasinya dengan perincian sebagai berikut :

Nama : Dian Octavia
NIM : 41214120004
Program Studi : Teknik Arsitektur
Lembaga/Perusahaan : Konsultan Arsitek.
Lama Magang : 03 Sept 2018 – 31 Des 2018

Penilaian	Nilai Angka (NA)	Bobot (B)	NAxB	Konversi Nilai
Tingkat Kemutakhiran dan Kesesuaian Obyek Magang dengan Ilmu Arsitektur	80	10%	8	80 – 100 = A+ 74 - < 80 = B+ 68 - < 74 = B 62 - < 68 = C+ 56 - < 62 = C 46 - < 56 = D 0 - < 46 = E
Kehadiran di Lapangan	80	20%	16	
Keseriusan & Kemampuan untuk Menyelesaikan Tugas	90	10%	9	
Penguasaan Materi	90	40%	36	
Tata Cara Penulisan Laporan	80	10%	8	
Presentasi	80	10%	8	
Total Nilai dari Pembimbing (NPB)			85	A
Total Nilai dari Perusahaan (NPR)			83	
Nilai Akhir = NPB (60%) + NPR (40%)			82	

Laporan Praktik Profesi tersebut telah disetujui dan memenuhi syarat. Demikian kami sampaikan, atas perhatiannya kami ucapkan terima kasih.

Hormat kami,

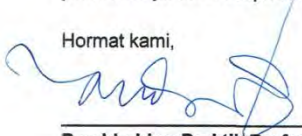

Pembimbing Praktik Profesi

Menyetujui,

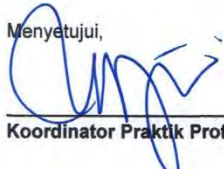

Koordinator Praktik Profesi

Tembusan Yth.
1. Pembimbing Akademik
2. Arsip

Lampiran 5

TRENDRAMA
architect

Jakarta, 13 Agustus 2018

Perihal : Surat Konfirmasi Praktek Profesi

Kepada Yth.
Bapak Ir. Joni Hardi, MT
Ketua Program Studi Teknik Arsitektur
Universitas Mercu Buana
Di tempat

Dengan Hormat,

Sehubungan dengan surat Bapak No. 13-2-5/337/F-KP/VII/2018 tanggal 13 Agustus 2018 tentang permohonan Praktek Profesi pada perusahaan kami, bersama ini kami sampaikan bahwa **Trendrama Architect** berkenan untuk menerima permohonan tersebut dari mahasiswa di bawah ini :

NO	NAMA MAHASISWA	NIM	DURASI
1	Dian Octavia	41214120004	03 Sept 2018 – 31 Des 2018

Selama berlangsungnya kegiatan Magang, para peserta akan ditempatkan di Divisi Arsitektur. Demikian yang dapat disampaikan, atas perhatian Bapak, kami ucapkan terima kasih.

Hormat kami,

TRENDRAMA
architect

Rama Candra
Director

Lampiran 6

 UNIVERSITAS MERCU BUANA	SURAT PERMOHONAN BIMBINGAN PRAKTIK PROFESI PROGRAM STUDI ARSITEKTUR		Q	
	No. Dokumen	061.423.4.70.00		Distribusi
	Tgl. Efektif	01 September 2013		

Jakarta, 18 Agustus 2018

Kepada Yth.
Koordinator Praktik Profesi Program Studi Teknik Arsitektur
Di Tempat

Perihal: Surat Permohonan Bimbingan Praktik Profesi (SBPP)

Dengan hormat,

Bersama ini Kami sampaikan bahwa mahasiswa Program Studi Teknik Arsitektur Fakultas Teknik berikut ini:

Nama : DIAN OCTAVIA NIM : 41214120004

Mendaftarkan diri untuk mengikuti magang/praktik profesi dan telah melengkapi persyaratan sebagai berikut:

1. Mahasiswa **WAJIB** lulus mata kuliah **Manajemen Konstruksi, Struktur & Utilitas 5 dan Perancangan Arsitektur 5** dengan nilai **minimal C**.
2. Mahasiswa wajib menempuh minimal **120 SKS**
3. Mendapatkan Surat Konfirmasi diterima Kerja Praktik oleh Perusahaan
4. Transkrip nilai sampai dengan semester akhir
5. Surat Permohonan Bimbingan Praktik Profesi telah di tanda tangani oleh Pembimbing Akademik

Kepada saya akan diberikan pembimbing dengan ketentuan masa bimbingan magang sbb:

Periode Magang di Perusahaan : 3 September 2018 s/d 15 Februari 2019

Periode Bimbingan Dosen : 3 September 2018 s/d 15 Februari 2019

Dosen Pembimbing Magang : Ir. Andjar Widjajanti, M. Ar.

Judul Proyek : Tanah Abang OFFICE 43

Pengumpulan Laporan : 16 Februari 2019

Dengan ini saya berjanji untuk mematuhi tata tertib dan prosedur magang/praktik profesi. Apabila di kemudian hari terjadi pelanggaran, maka saya bersedia menerima sanksi yang telah ditentukan.

Demikian saya sampaikan. Atas perhatian dan kerjasamanya kami ucapkan terima kasih.

Hormat Saya,

DIAN OCTAVIA
Pemohon

Koordinator Praktik Profesi

Mengetahui,

Pembimbing Akademik

Tebusan Yth:

1. Dosen Pembimbing Praktik Profesi Profesi
2. Arsip

Lampiran 7

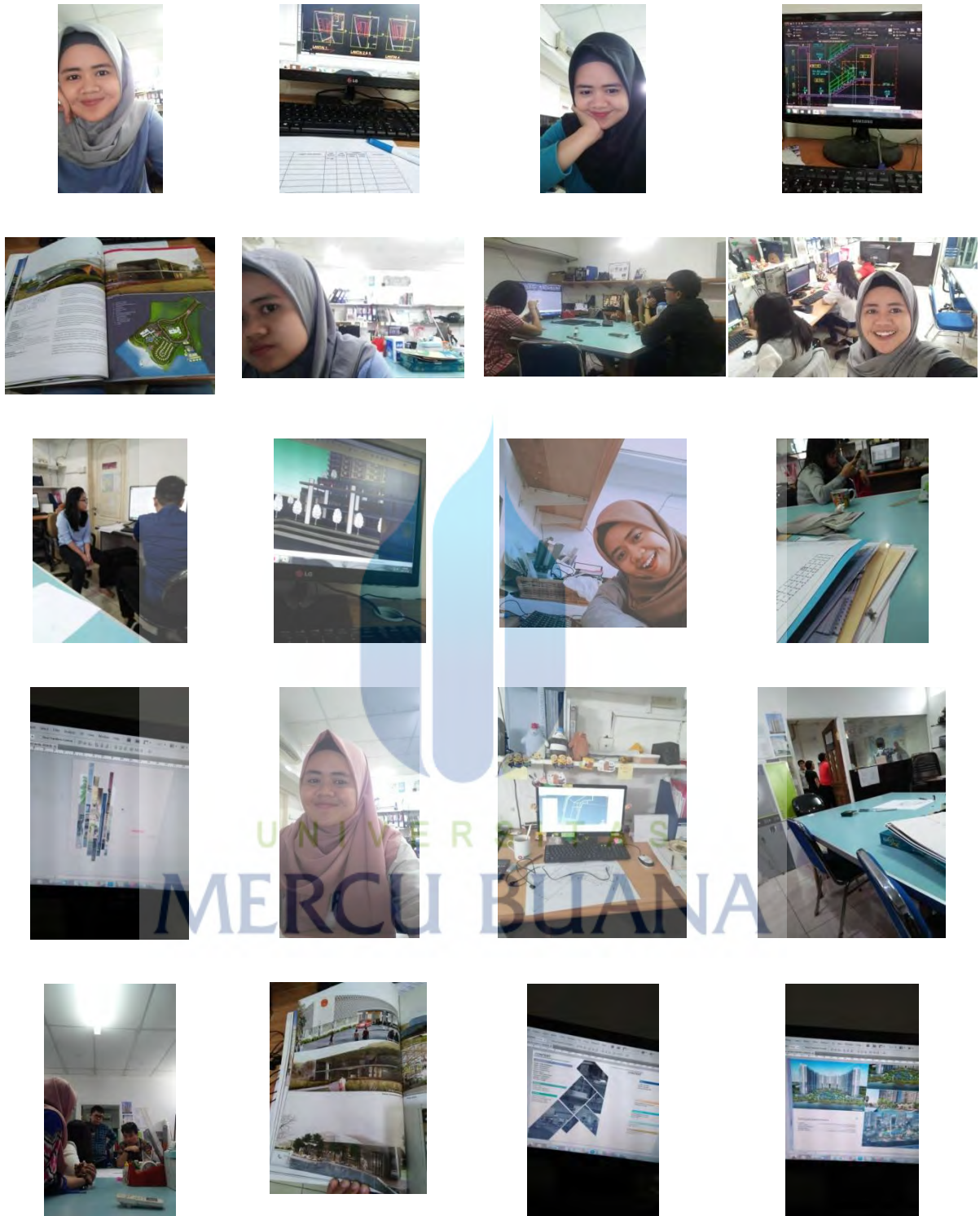

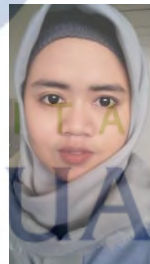
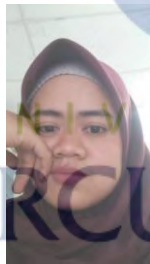
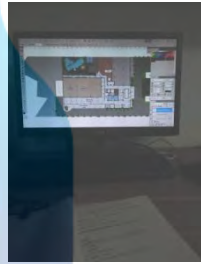
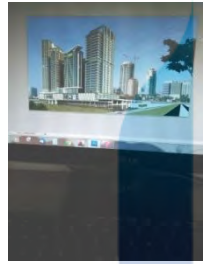
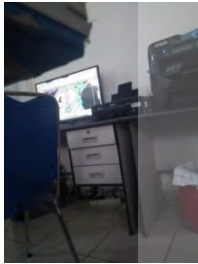
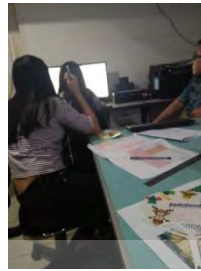
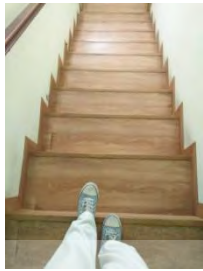
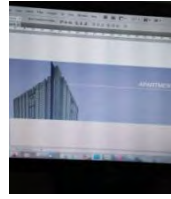

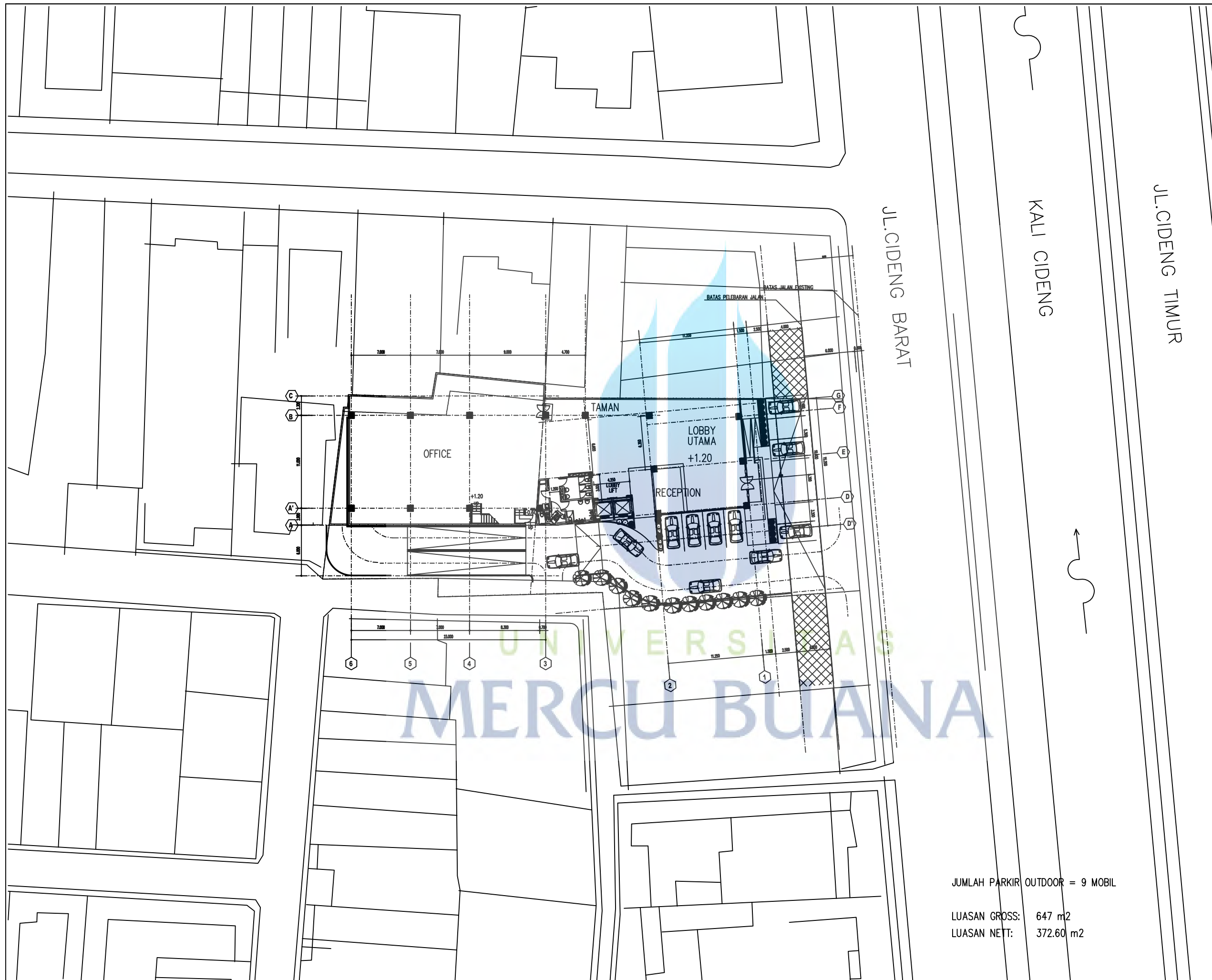

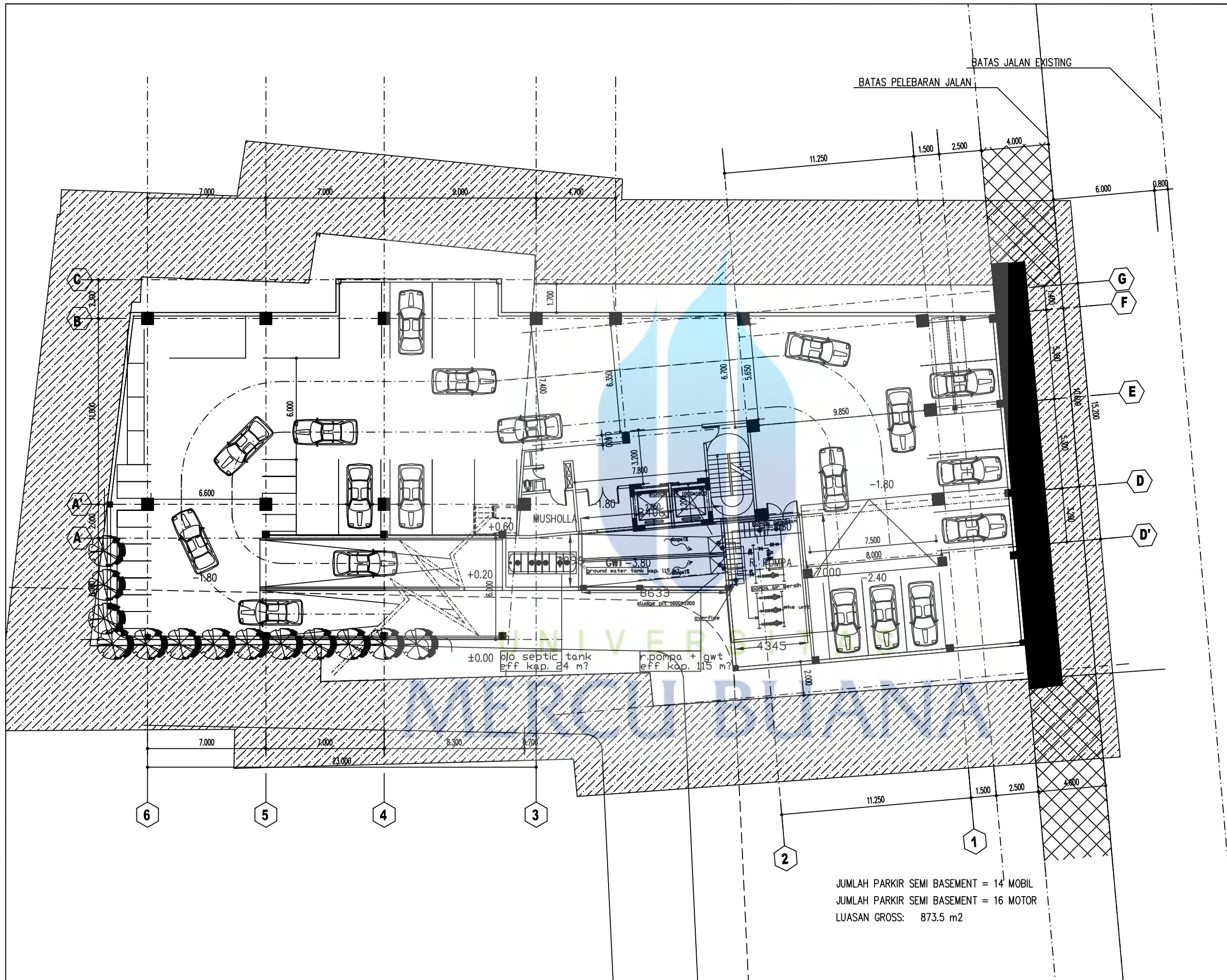

JUMLAH PARKIR OUTDOOR = 9 MOBIL
 LUASAN GROSS: 647 m²
 LUASAN NETT: 372.60 m²

CATATAN		
NO	REVISI	TANGGAL PARAF
KEYPLAN		
PROYEK		
- OFFICE CIDENG -		
JL. CIDENG BARAT 46D-47		
OWNER/DEVELOPER		
PANCA in HOUSE		
KONSULTAN ARSITEK		
TRENDRAMA ARCHITECT BENG_2001@YAHOO.COM		
KONSULTAN STRUKTUR		
SUYANDRA n PARTNERS SIBP. 0005/P/KA/DPPB/V-2009 T. 021-65308047, E. suyandra@cbn.net.id		
KONSULTAN ME		
 Mitra Perdana Engineering Mechanical & Electrical Consultant Perkantoran Prima Indaya Blok/2, 4th Floor, Jakarta Barat - 10330 Phone : 021 5267289 Fax : 021 5267229 E-mail : mitra_perdana@mitra_perdana.com / mpe_mitramperdana.com		
KONSULTAN LANSEKAP		
KONTRAKTOR		
JUDUL GAMBAR		
STE PLAN		
DIGAMBAR :	DIPERIKSA :	SKALA :
MNK	-	1 : 100 on A1
TANGGAL :	DISETUIJUI :	NO. REVISI :
-	-	-
NO. PROYEK	NO. GAMBAR	NO. LBR
AR-KHK-	03-012	A3-00



JUMLAH PARKIR SEMI BASEMENT = 14 MOBIL
 JUMLAH PARKIR SEMI BASEMENT = 16 MOTOR
 LUASAN GROSS: 873.5 m2

CATATAN		
NO	REVISI	TANGGAL PARAF
KEYPLAN		
PROYEK		
- OFFICE CIDENG -		
JL. CIDENG BARAT 46D-47		
OWNER/DEVELOPER		
PANCA in HOUSE		
KONSULTAN ARSITEK		
TRENDRAMA ARCHITECT BENG_2001@YAHOO.COM		
KONSULTAN STRUKTUR		
SUYANDRA n PARTNERS SIBP. 0005/P/KA/DPPB/V-2009 T. 021-65308047, E. suyandra@cbn.net.id		
KONSULTAN ME		
 Mitra Perdana Engineering Mechanical & Electrical Consultant Perkantoran Prima Gedung Duta/7, 4th Floor, Jakarta Barat - 10310 Phone : 021 5307189 Fax : 021 5307189 E-mail : mitra_perda@indosat.net.id / mpe_mitraperdaing.com		
KONSULTAN LANSEKAP		
KONTRAKTOR		
JUDUL GAMBAR		
DENAH SEMI BASEMENT		
DIGAMBAR :	DIPERIKSA :	SKALA :
TANGGAL :	DISETUI :	NO.REVISI :
NO. PROYEK	NO. GAMBAR	NO.LBR
		A3 -

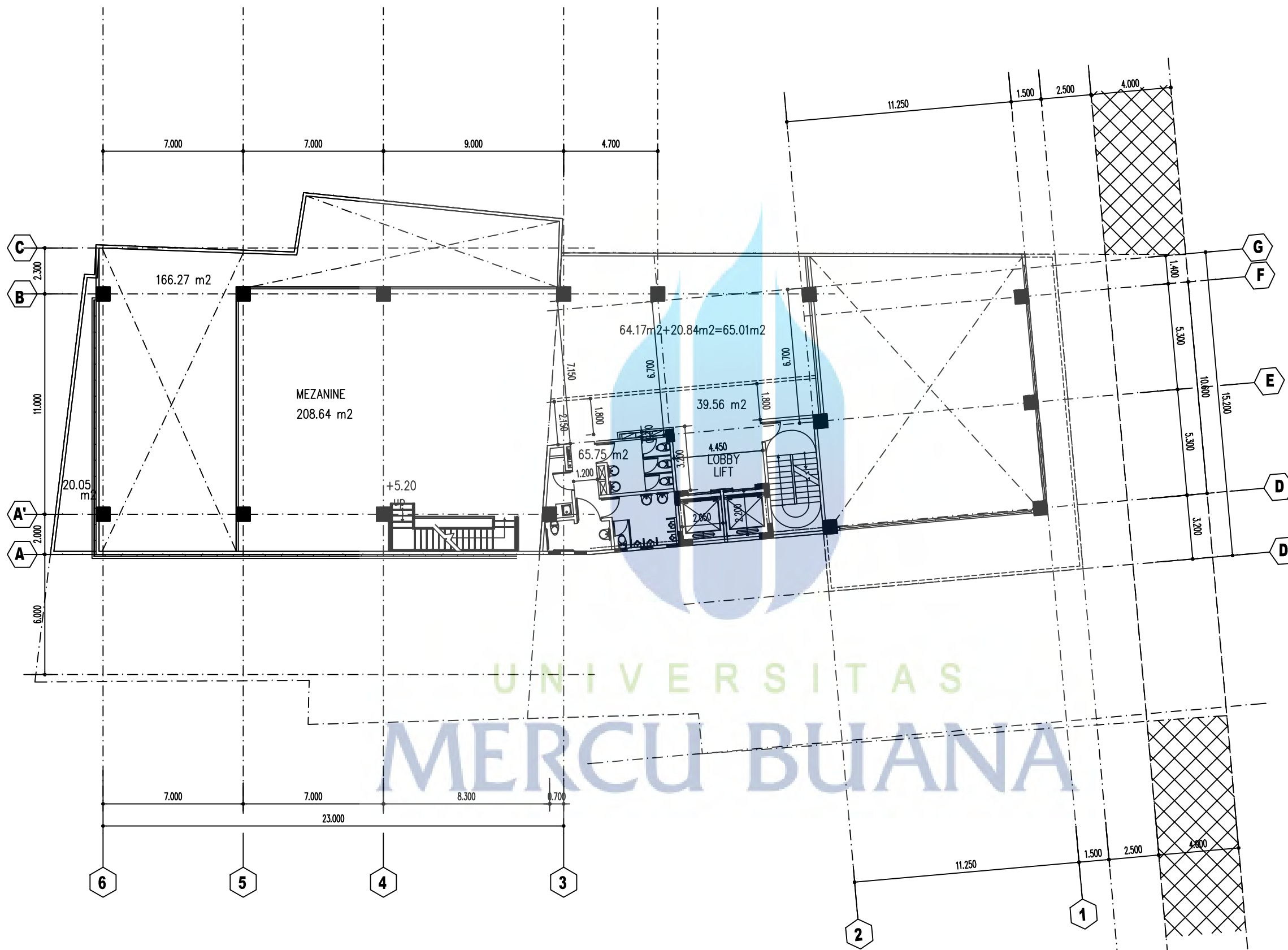

LUASAN GROSS: 204.25 + 162.61 = 366.86 m²
 LUASAN NETT: 204.25 m²

CATATAN

NO	REVISI	TANGGAL PARAF

KEYPLAN

PROYEK

- OFFICE CIDENG -
 JL. CIDENG BARAT 46D-47

OWNER/DEVELOPER

PANCA in HOUSE

KONSULTAN ARSITEK

TRENDRAMA
 ARCHITECT
 BENG_2001@YAHOO.COM

KONSULTAN STRUKTUR

SUYANDRA n PARTNERS
 SIBP. 0005/P/KA/DPPB/V-2009
 T. 021-65308047, E. suyandra@cbn.net.id

KONSULTAN ME

Mitra Perdana Engineering
 Mechanical & Electrical Consultant
 Perkantoran Prima Gedung Dik/7, 4th Floor, Jakarta Barat - 10530
 Phone : 021 5307589
 Fax : 021 5307529
 E-mail : mitra_perdana@ymail.com / mpe_mitra@perdana.com

KONSULTAN LANSEKAP

KONTRAKTOR

JUDUL GAMBAR

DENAH LANTAI MEZANIN

DIGAMBAR :	DIPERIKSA :	SKALA :
-	-	1 : 1 : 200
TANGGAL :	DISETUIJUI :	NO.REVISI :
-	-	-
NO. PROYEK	NO. GAMBAR	NO.LBR
		A3 -

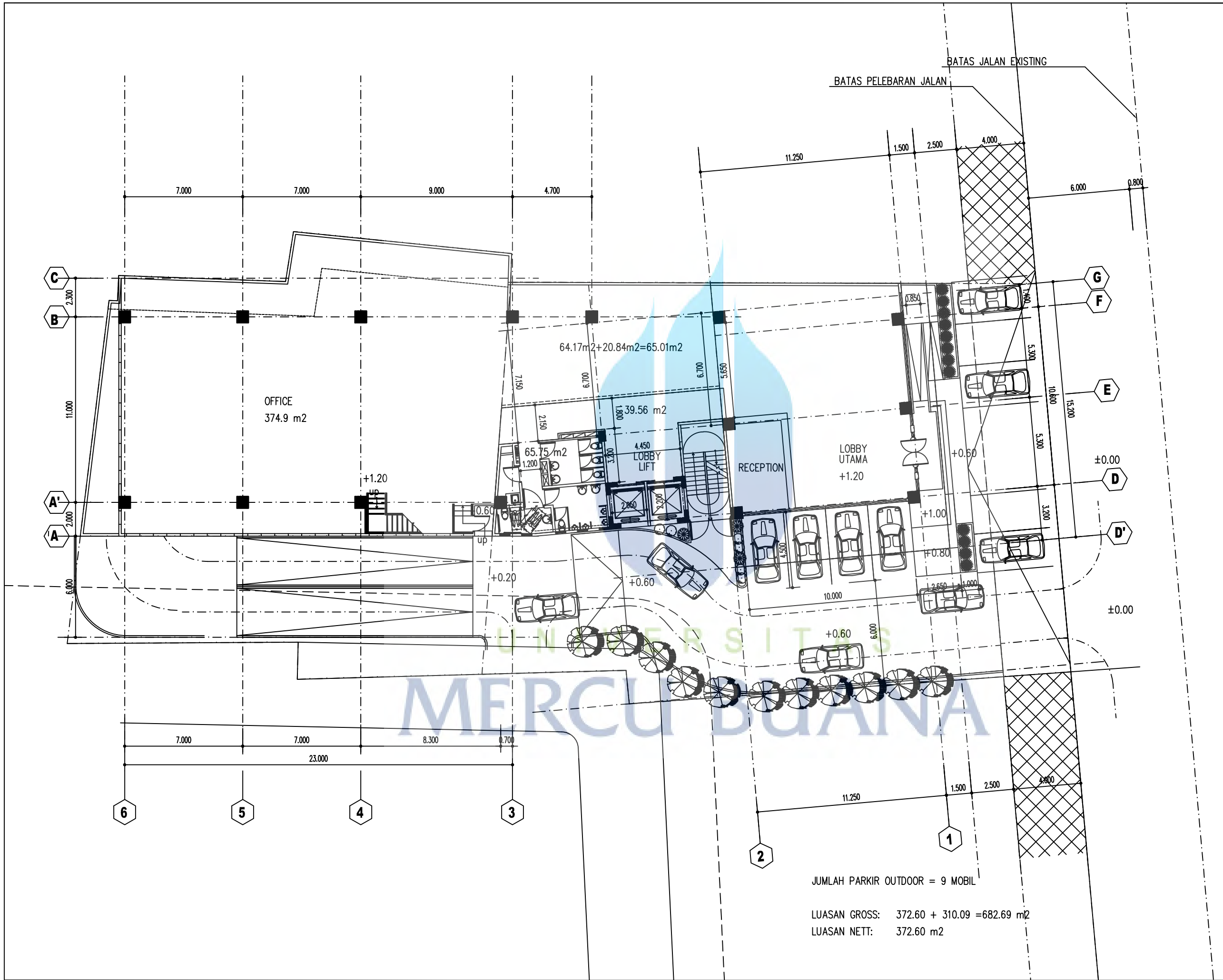

CATATAN		
NO	REVISI	TANGGAL PARAF
KEYPLAN		
PROYEK		
- OFFICE CIDENG -		
JL. CIDENG BARAT 46D-47		
OWNER/DEVELOPER		
PANCA in HOUSE		
KONSULTAN ARSITEK		
TRENDRAMA ARCHITECT BENG_2001@YAHOO.COM		
KONSULTAN STRUKTUR		
SUYANDRA n PARTNERS SIBP. 0005/P/KA/DPPB/V-2009 T. 021-65308047, E. suyandra@cbn.net.id		
KONSULTAN ME		
 Mitra Perdana Engineering Mechanical & Electrical Consultant Perkantoran Prima Gedung Dik/1, 4th Floor, Jln. Cideng Barat - 462 Phone : 021 5367289 Fax : 021 5367289 E-mail : mitra_perdana@mitra_perdana.com / mpe_mitra@mitra_perdana.com		
KONSULTAN LANSEKAP		
KONTRAKTOR		
JUDUL GAMBAR		
DENAH LANTAI DASAR		
DIGAMBAR :	DIPERIKSA :	SKALA :
-	-	1 : 1 : 200
TANGGAL :	DISETUI :	NO. REVISI :
-	-	-
NO. PROYEK	NO. GAMBAR	NO. LBR
		A3 -

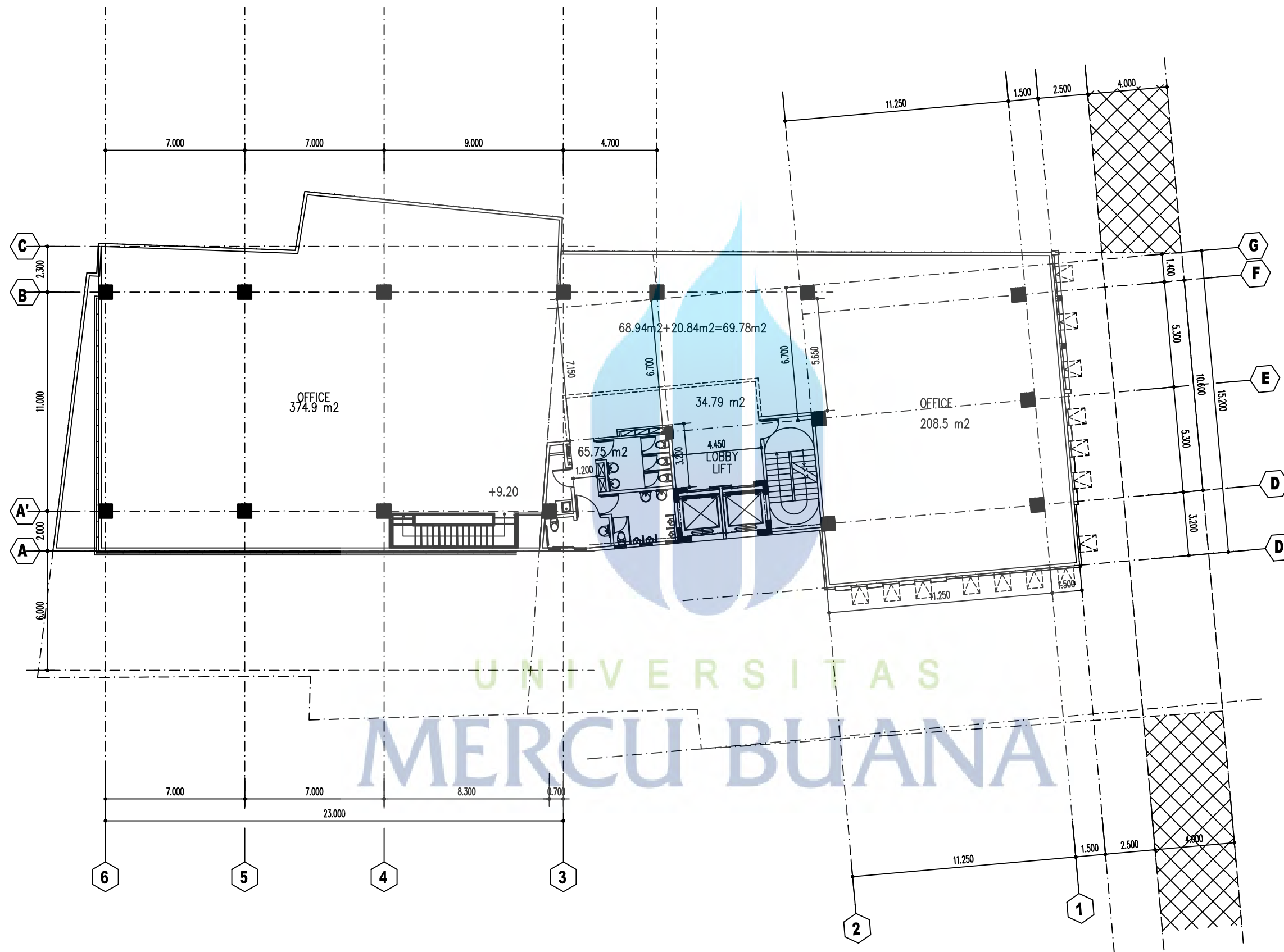

LUASAN GROSS: $372.60 + 367.60 = 740.20 \text{ m}^2$
 LUASAN NETT: $372.60 + 208.5 = 581.1 \text{ m}^2$

CATATAN

NO	REVISI	TANGGAL PARAF

KEYPLAN

PROYEK

- OFFICE CIDENG -
 JL. CIDENG BARAT 46D-47

OWNER/DEVELOPER

PANCA in HOUSE

KONSULTAN ARSITEK

TRENDRAMA
 ARCHITECT
 BENG_2001@YAHOO.COM

KONSULTAN STRUKTUR

SUYANDRA n PARTNERS
 SIBP. 0005/P/KA/DPPB/V-2009
 T. 021-65308047, E. suyandra@cbn.net.id

KONSULTAN ME

Mitra Perdana Engineering
 Mechanical & Electrical Consultant
 Perkantoran Prima Gedung Dik/7, 4th Floor, Jakarta Barat - 10530
 Phone : 021 5307389
 Fax : 021 5307329
 E-mail : mitra_perdana@mitra_perdana.com

KONSULTAN LANSEKAP

KONTRAKTOR

JUDUL GAMBAR

DENAH LANTAI 2

DIGAMBAR :	DIPERIKSA :	SKALA :
-	-	1 : 1:200
TANGGAL :	DISETUJUI :	NO.REVISI :
-	-	-
NO. PROYEK	NO. GAMBAR	NO.LBR
		A3-

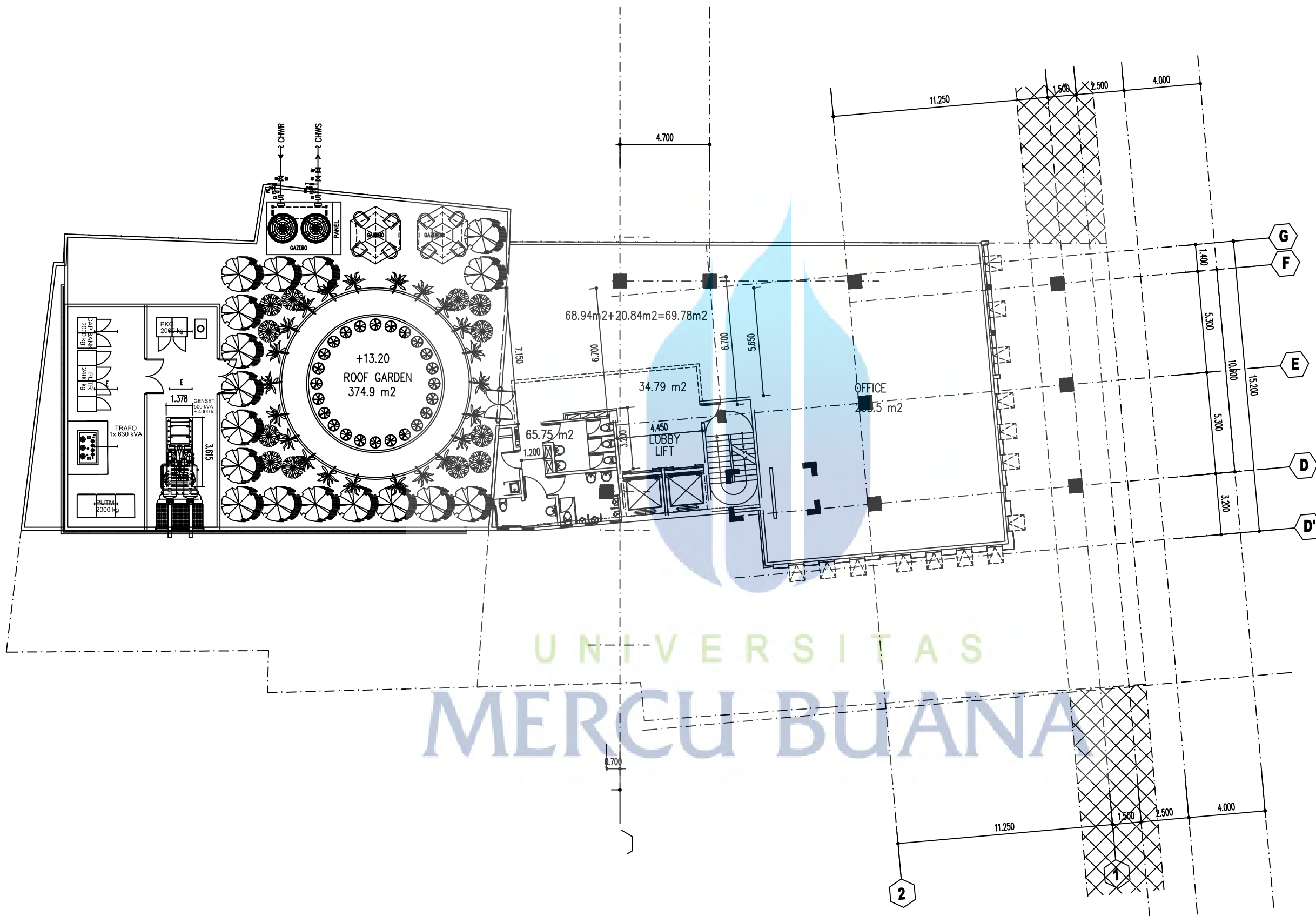

LUASAN GROSS: 367.60 m²
 LUASAN NETT: 208.5 m²

CATATAN

NO	REVISI	TANGGAL PARAF

KEYPLAN

PROYEK

- OFFICE CIDENG -
 JL. CIDENG BARAT 46D-47

OWNER/DEVELOPER

PANCA in HOUSE

KONSULTAN ARSITEK

TRENDRAMA
 ARCHITECT
 BENG_2001@YAHOO.COM

KONSULTAN STRUKTUR

SUYANDRA n PARTNERS
 SIBP. 0005/P/KA/DPPB/V-2009
 T. 021-65308047, E. suyandra@cbn.net.id

KONSULTAN ME

Mitra Perdana Engineering
 Mechanical & Electrical Consultant
 Perkantoran Prima Indaya Blok/1, 4th Floor, Jember Barat - 65131
 Phone : 0324 5367389
 Fax : 0324 5367329
 E-mail : mitra_perdana@ymail.com / mpe_mitra@indosat.net.id

KONSULTAN LANSEKAP

KONTRAKTOR

JUDUL GAMBAR

DENAH LANTAI 3

DIGAMBAR :	DIPERIKSA :	SKALA :
-	-	1 : 1.200
TANGGAL :	DISETUIJUI :	NO.REVISI :
-	-	-
NO. PROYEK	NO. GAMBAR	NO.LBR
		A3-

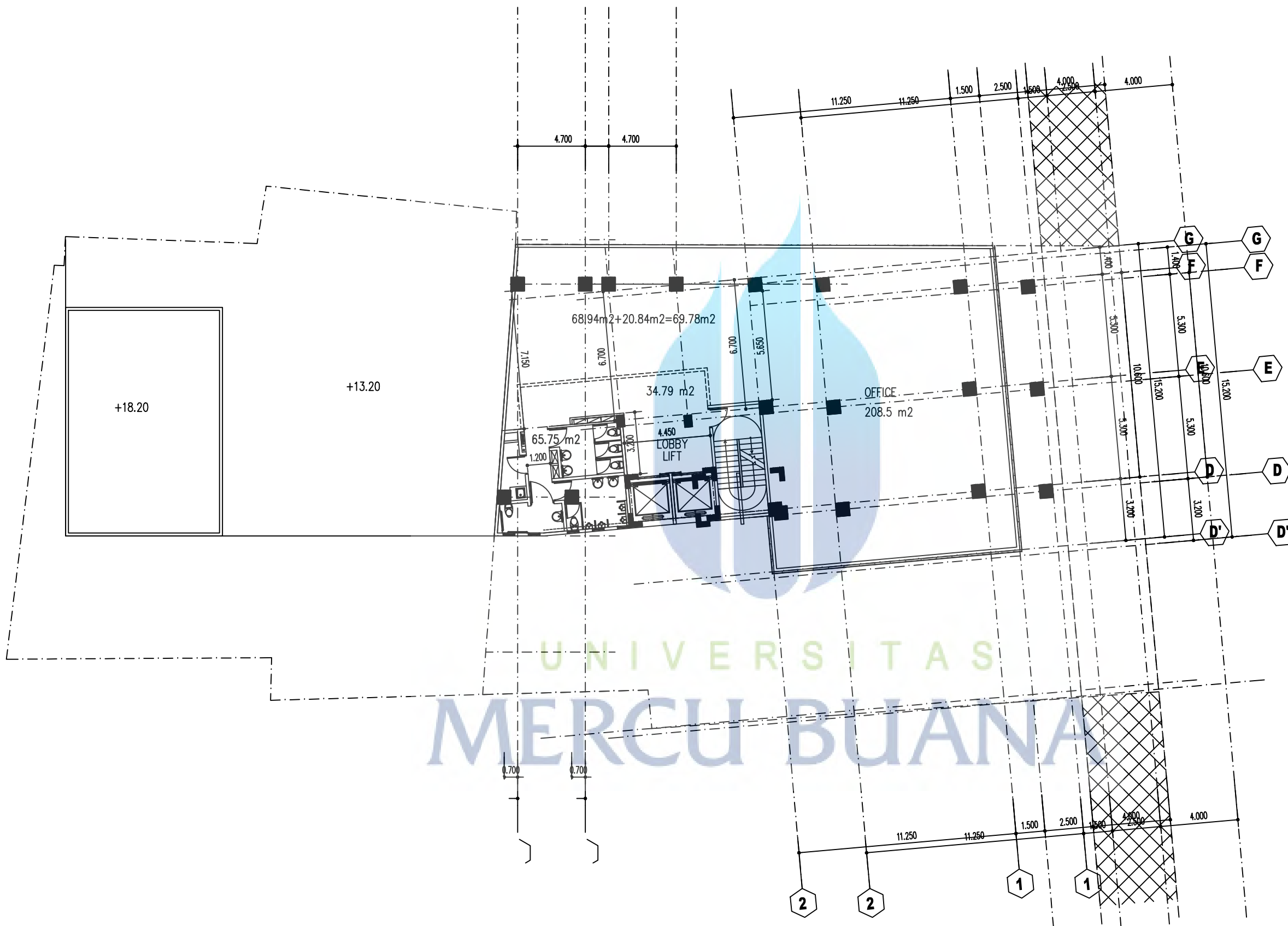

LUASAN GROSS: 367.60 m²
 LUASAN NETT: 208.5 m²

CATATAN

NO	REVISI	TANGGAL PARAF

KEYPLAN

PROYEK

- OFFICE CIDENG -
 JL. CIDENG BARAT 46D-47

OWNER/DEVELOPER

PANCA in HOUSE

KONSULTAN ARSITEK

TRENDRAMA
 ARCHITECT
 BENG_2001@YAHOO.COM

KONSULTAN STRUKTUR

SUYANDRA n PARTNERS
 SIBP. 0005/P/KA/DPPB/V-2009
 T. 021-65308047, E. suyandra@cbn.net.id

KONSULTAN ME

Mitra Perdana Engineering
 Mechanical & Electrical Consultant
 Perkantoran Prima Gedung Dik/7, 4th Floor, Jakarta Barat - 1039
 Phone : 021 5307589
 Fax : 021 5307579
 E-mail : mitra_perdana@mitra_perdana.com / mpe_mitra@mitra_perdana.com

KONSULTAN LANSEKAP

KONTRAKTOR

JUDUL GAMBAR

DENAH LANTAI 4-5

DIGAMBAR :	DIPERIKSA :	SKALA :
TANGGAL :	DISETUIJI :	NO.REVISI :
NO. PROYEK	NO. GAMBAR	NO.LBR
		A3 -

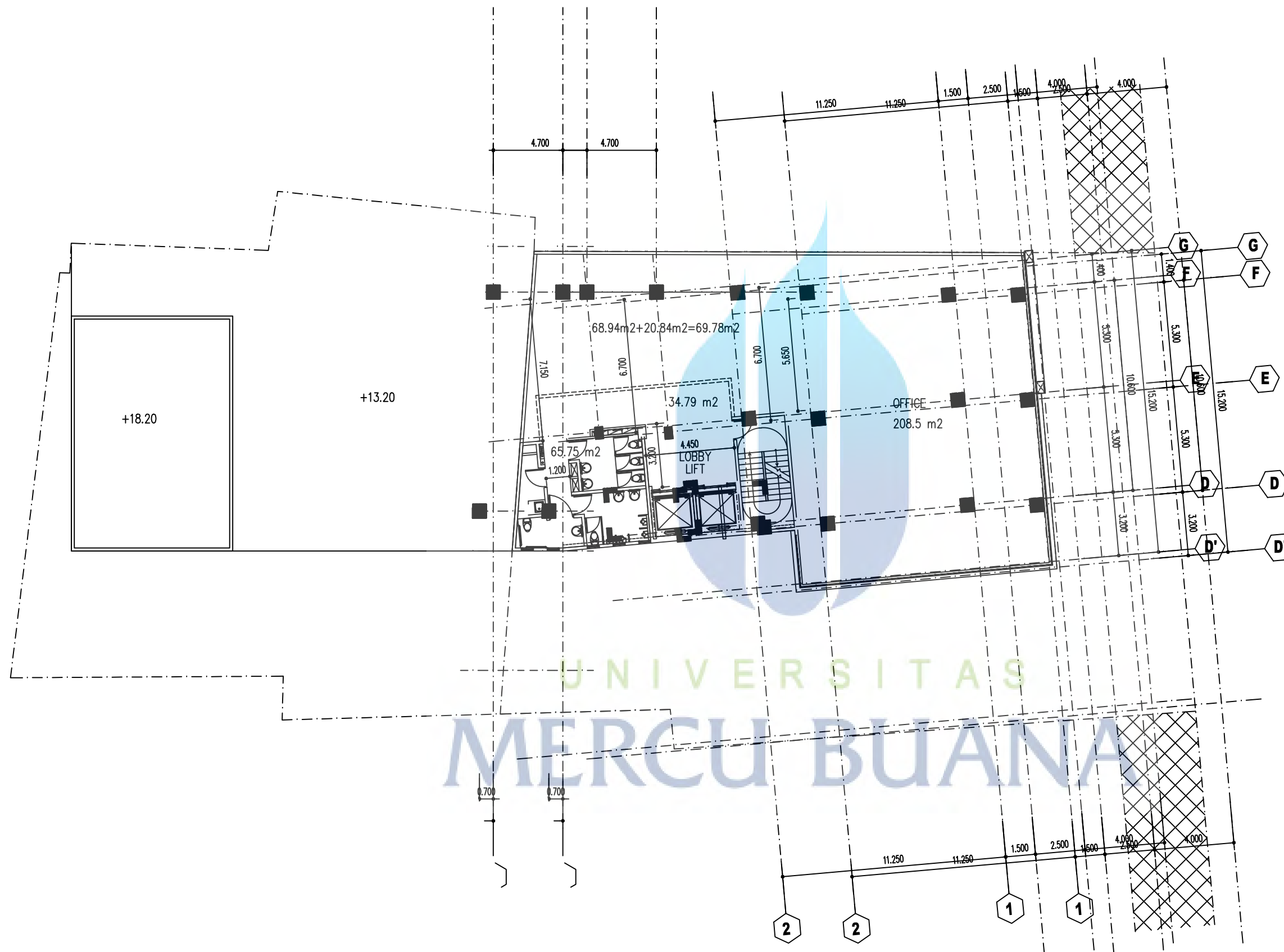

LUASAN GROSS: 367.60 m2
 LUASAN NETT: 208.5 m2

CATATAN

NO	REVISI	TANGGAL PARAF

KEYPLAN

PROYEK

- OFFICE CIDENG -

JL. CIDENG BARAT 46D-47

OWNER/DEVELOPER

PANCA in HOUSE

KONSULTAN ARSITEK

TRENDRAMA
 ARCHITECT
 BENG_2001@YAHOO.COM

KONSULTAN STRUKTUR

SUYANDRA n PARTNERS
 SIBP. 0005/P/KA/DPPB/V-2009
 T. 021-65308047, E. suyandra@cbn.net.id

KONSULTAN ME

Mitra Perdana Engineering
 Mechanical & Electrical Consultant
 Perkantoran Prima Gedung Dik/7, 4th Floor, Jl. Cideng Barat - 4638
 Phone : 021 5367389
 Fax : 021 5367329
 E-mail : mitra_perdana@mitra_perdana.com / mpe_mitraperdana@gmail.com

KONSULTAN LANSEKAP

KONTRAKTOR

JUDUL GAMBAR

DENAH LANTAI 6

DIGAMBAR :	DIPERIKSA :	SKALA :
-	-	1 : 1 : 200
TANGGAL :	DISETUIJI :	NO.REVISI :
-	-	-
NO. PROYEK	NO. GAMBAR	NO.LBR
		A3-

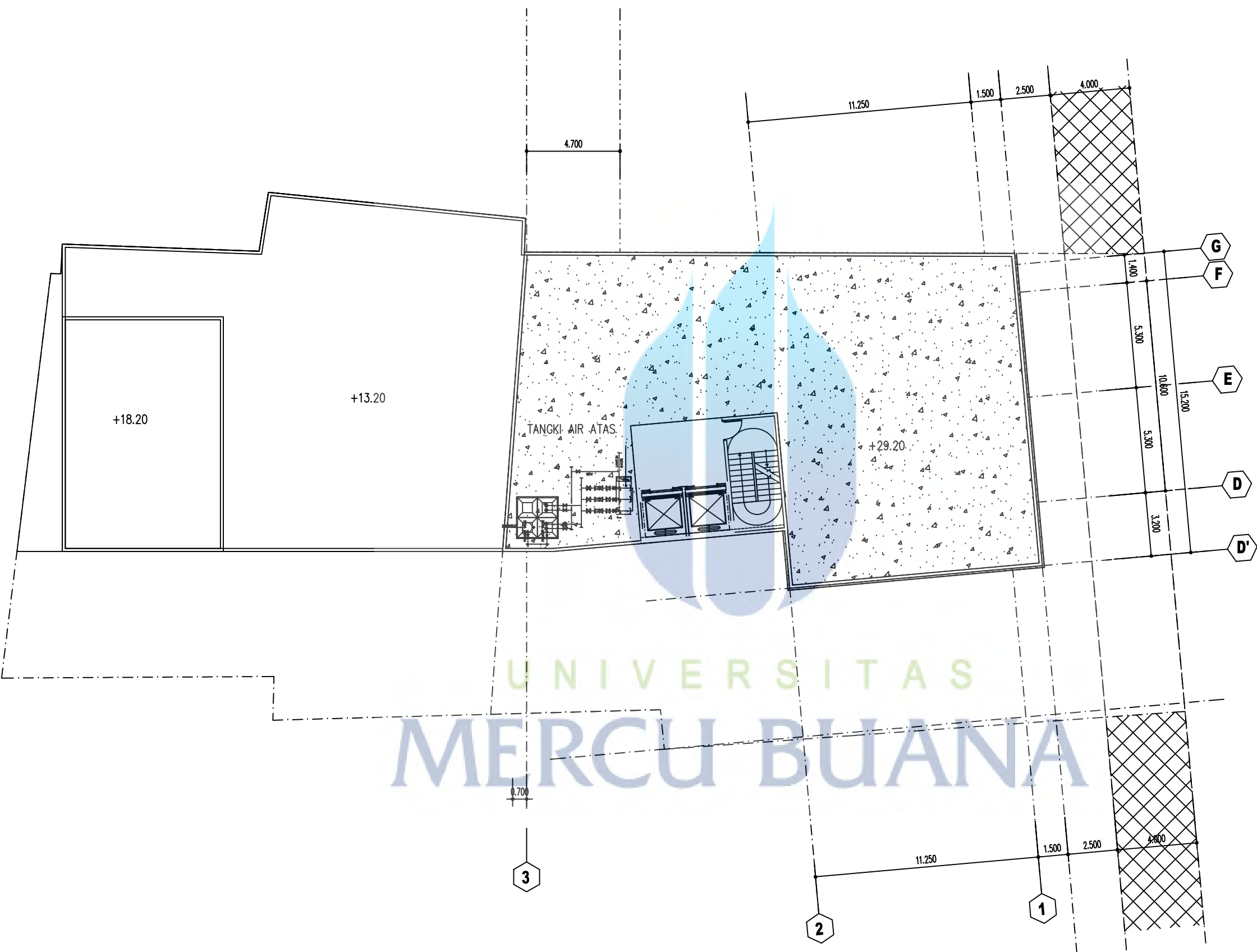

CATATAN

NO	REVISI	TANGGAL PARAF

KEYPLAN

PROYEK

- OFFICE CIDENG -
JL. CIDENG BARAT 46D-47

OWNER/DEVELOPER

PANCA in HOUSE

KONSULTAN ARSITEK

TRENDRAMA
ARCHITECT
BENG_2001@YAHOO.COM

KONSULTAN STRUKTUR

SUYANDRA n PARTNERS
SIBP. 0005/P/KA/DPPB/V-2009
T. 021-65308047, E. suyandra@cbn.net.id

KONSULTAN ME

Mitra Perdana Engineering
Mechanical & Electrical Consultant
Perumahan Prima Kodya Dki/7, 4th Floor, Jakarta Barat - 1538
Phone : 021 5367389
Fax : 021 5367379
E-mail : mitra_perdana@mitra_perdana.com / mpe_mitraperdana@gmail.com

KONSULTAN LANSEKAP

KONTRAKTOR

JUDUL GAMBAR

DENAH LANTAI ATAP

DIGAMBAR :	DIPERIKSA :	SKALA :
-	-	1 : 1 : 200
TANGGAL :	DISETUIJUI :	NO. REVISI :
-	-	-
NO. PROYEK	NO. GAMBAR	NO. LBR
		A3 -

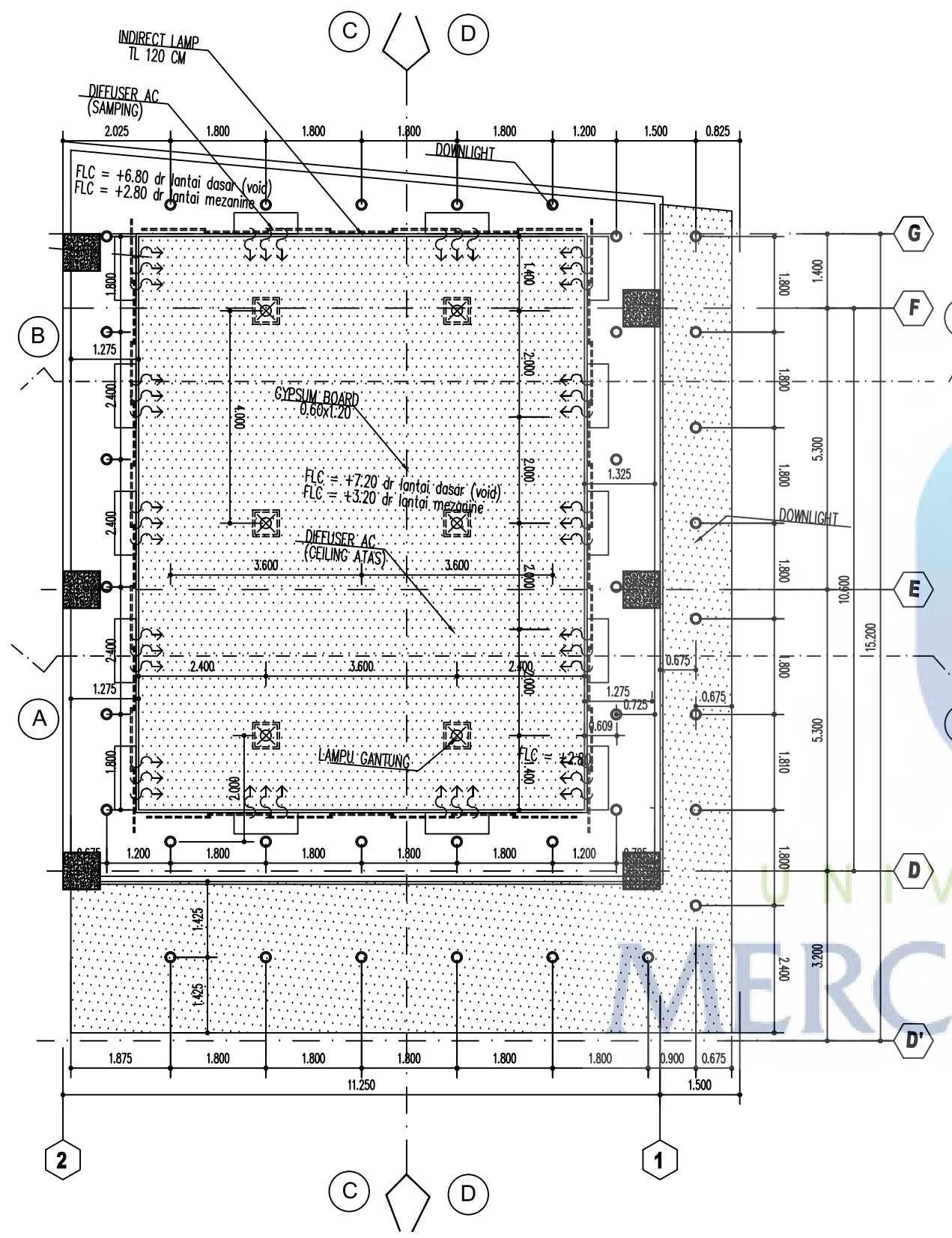

01 RENCANA POLA PLAFOND
SKALA : 1 : 100

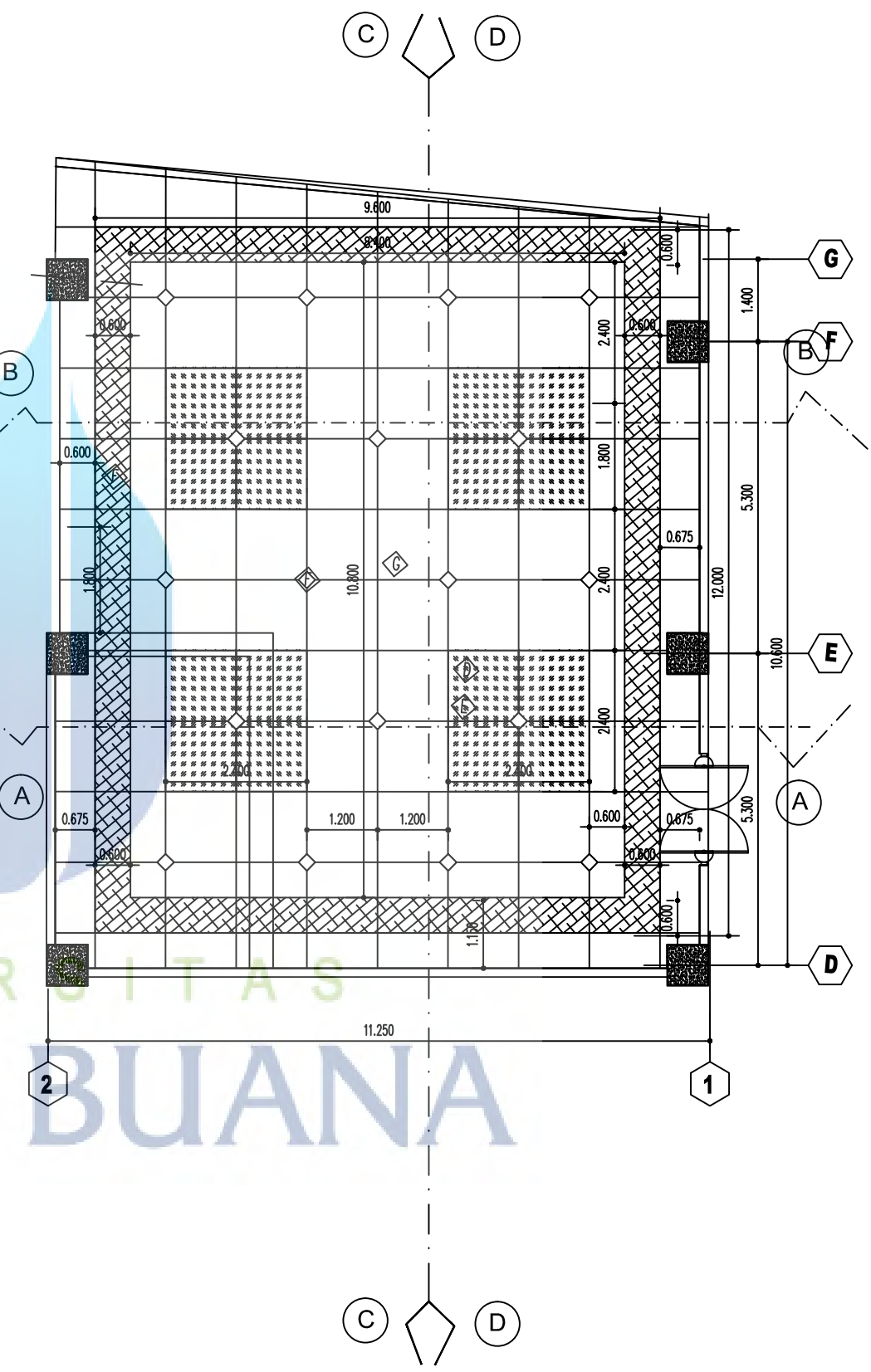

01 RENCANA POLA LANTAI
SKALA : 1 : 100

CATATAN		
◊ A	HOMOGENEOUS TILES 60 x 60	
◊ B	HOMOGENEOUS TILES 60 x 60	
◊ C	HOMOGENEOUS TILES 60 x 60	
◊ D	KARPET (By Tenant)	
◊ E	GRANIT	
◊ F	GRANIT	
◊ G	GRANIT	
NO	REVISI	TANGGAL PARAF
KEYPLAN		
PROYEK		
- OFFICE CIDENG -		
JL. CIDENG BARAT 46D-47		
OWNER/DEVELOPER		
PANCA in HOUSE		
KONSULTAN ARSITEK		
TRENDRAMA ARCHITECT BENG_2001@YAHOO.COM		
KONSULTAN STRUKTUR		
SUYANDRA n PARTNERS SIBP. 0005/P/KA/DPPB/V-2009 T. 021-65308047, E suyandra@cbn.net.id		
KONSULTAN ME		
 Mitra Perdana Engineering Mechanical & Electrical Consultant Perkantoran Prima Gedung Dik/7, 4th Floor, Jakarta Barat - 1039 Phone : 021 5307399 Fax : 021 5307329 E-mail : mitra_perma@indosat.net.id / mpe_mitra@indosat.net.id		
KONSULTAN LANSEKAP		
KONTRAKTOR		
JUDUL GAMBAR		
DETAIL LOBBY UTAMA LEMBAR 1		
DIGAMBAR :	DIPERIKSA :	SKALA :
-	-	1 : 100
TANGGAL :	DISETUI :	NO.REVISI :
-	-	-
NO. PROYEK	NO. GAMBAR	NO.LBR
		A3-

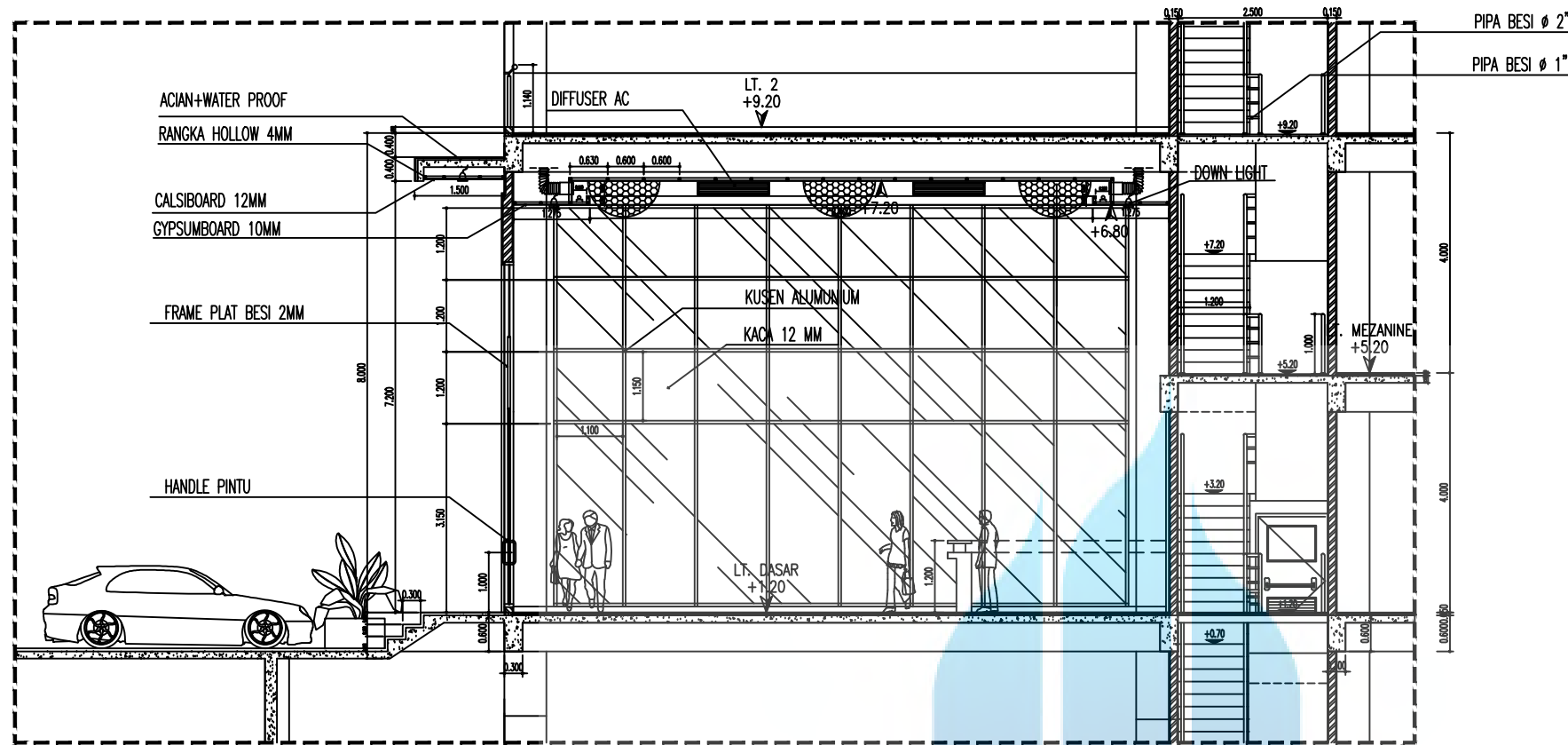

01 POTONGAN A-A'
SKALA : 1 : 100

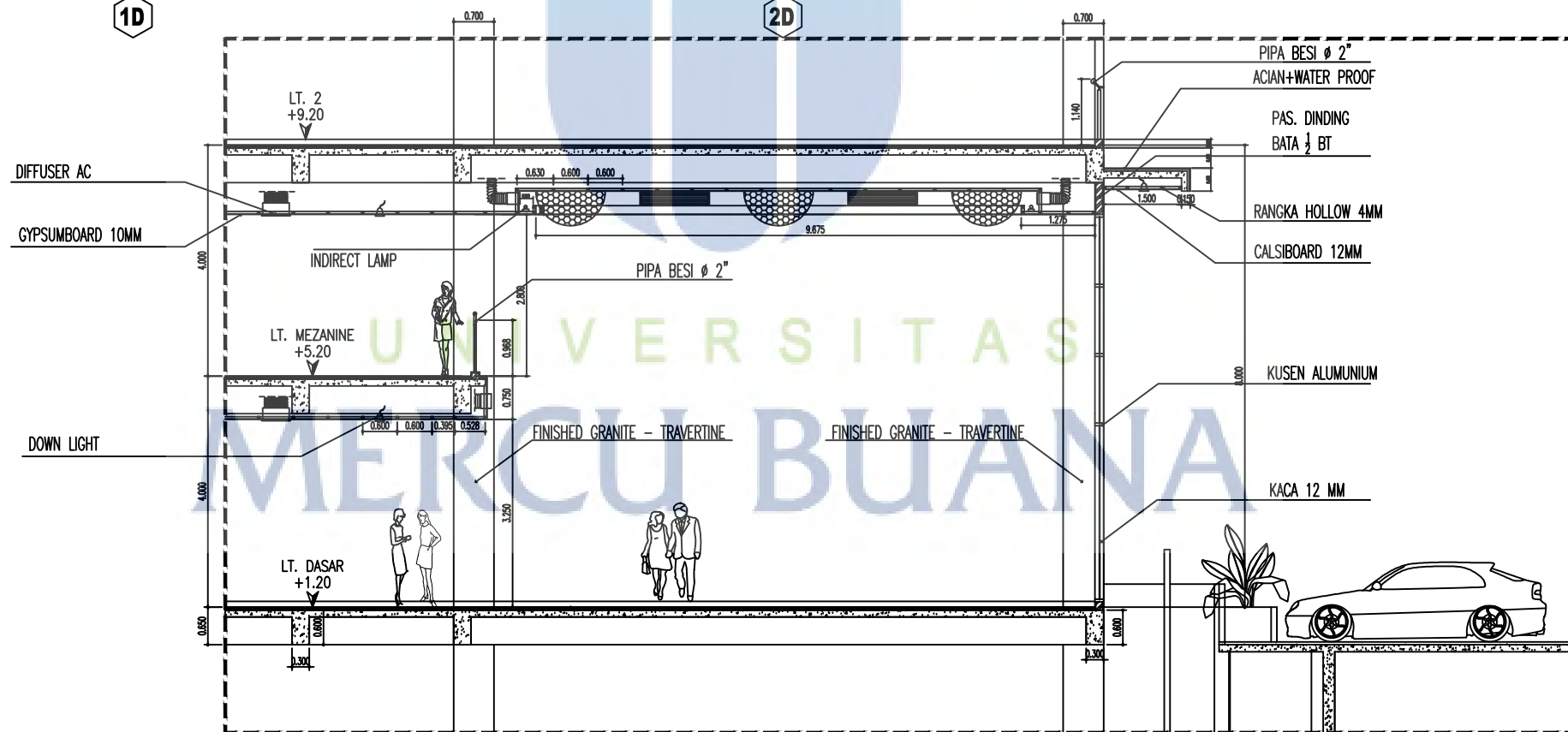

01 POTONGAN B-B'
SKALA : 1 : 100

CATATAN

NO	REVISI	TANGGAL PARAF

KEYPLAN
PROYEK

- OFFICE CIDENG -
JL. CIDENG BARAT 46D-47

OWNER/DEVELOPER

PANCA in HOUSE

KONSULTAN ARSITEK

TRENDRAMA
ARCHITECT
BENG_2001@YAHOO.COM

KONSULTAN STRUKTUR

SUYANDRA n PARTNERS
SIBP. 0005/P/KA/DPPB/V-2009
T. 021-65308047, E. suyandra@cbn.net.id

KONSULTAN ME

Mitra Perdana Engineering
Mechanical & Electrical Consultant
Perumahan Prima Satria Indah/VI, 4th Floor, Jakarta Barat - 1026
Phone : 021 5381700
Fax : 021 5381629
E-mail : mitra_perdana@indosat.net.id / mpe_mitraperdana@indosat.net.id

KONSULTAN LANSEKAP

KONTRAKTOR

JUDUL GAMBAR

DETAIL LOBBY UTAMA LEMBAR 1

DIGAMBAR :	DIPERIKSA :	SKALA :
TANGGAL :	DISETUIHUI :	NO.REVISI :
NO. PROYEK	NO. GAMBAR	NOLBR
		A3-

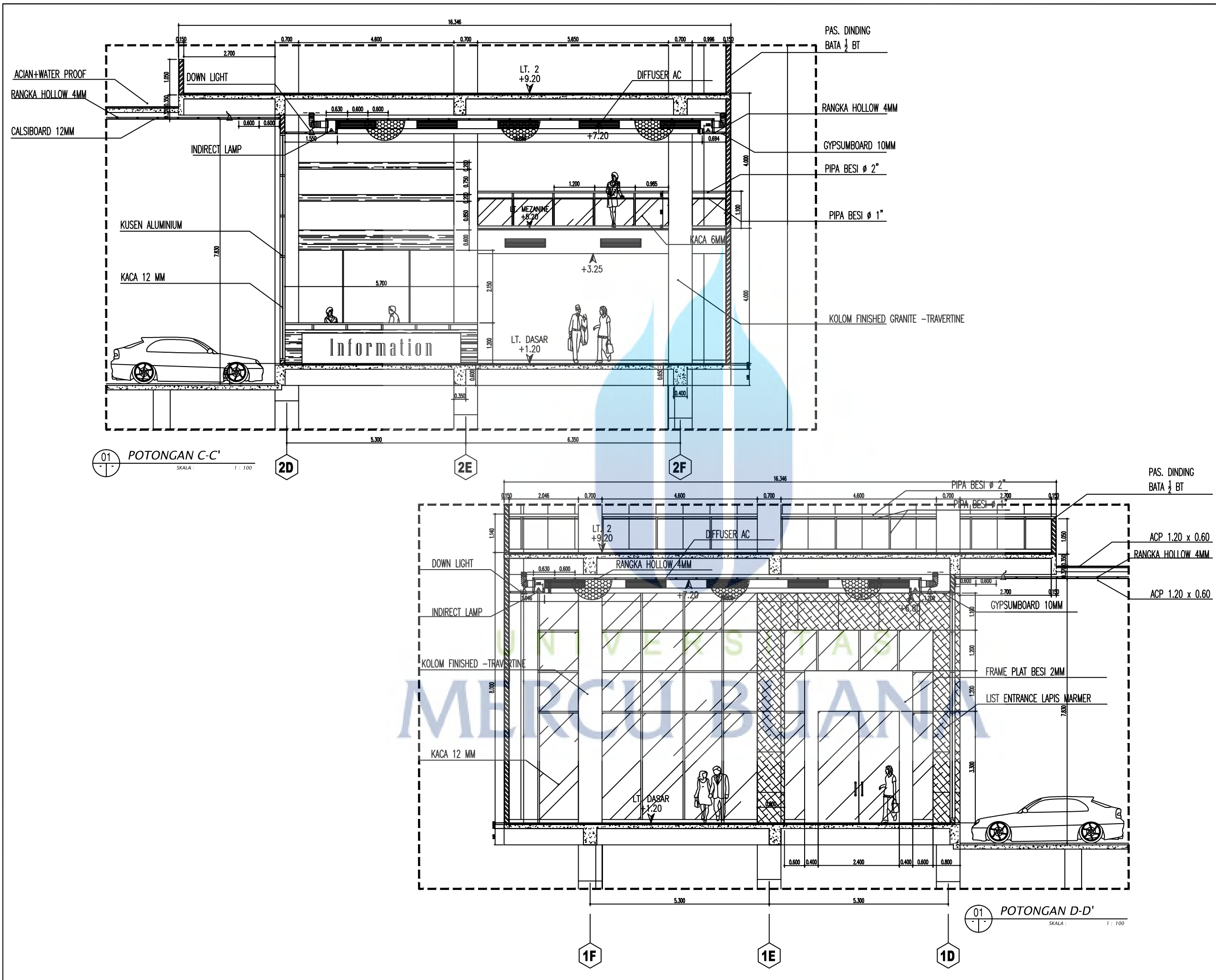

CATATAN		
NO	REVISI	TANGGAL PARAF
KEYPLAN		
PROYEK		
- OFFICE CIDENG -		
JL. CIDENG BARAT 46D-47		
OWNER/DEVELOPER		
PANCA in HOUSE		
KONSULTAN ARSITEK		
TRENDRAMA ARCHITECT BENG_2001@YAHOO.COM		
KONSULTAN STRUKTUR		
SUYANDRA n PARTNERS SIBP. 0005/P/KA/DPPB/V-2009 T. 021-65308047, E. suyandra@cbn.net.id		
KONSULTAN ME		
 Mitra Perdana Engineering Mechanical & Electrical Consultant Perkantoran Prima Gedung Dik/7, 4th Floor, Jakarta Barat - 10310 Phone : 021 5367389 Fax : 021 5367329 E-mail : mitra_perdana@indosat.net.id / mpe_mitra@indosat.net.id		
KONSULTAN LANSEKAP		
KONTRAKTOR		
JUDUL GAMBAR		
DETAIL LOBBY UTAMA LEMBAR 3		
DIGAMBAR :	DIPERIKSA :	SKALA :
TANGGAL :	DISETUI :	NO. REVISI :
NO. PROYEK :	NO. GAMBAR :	NO. LBR :
		A3 -

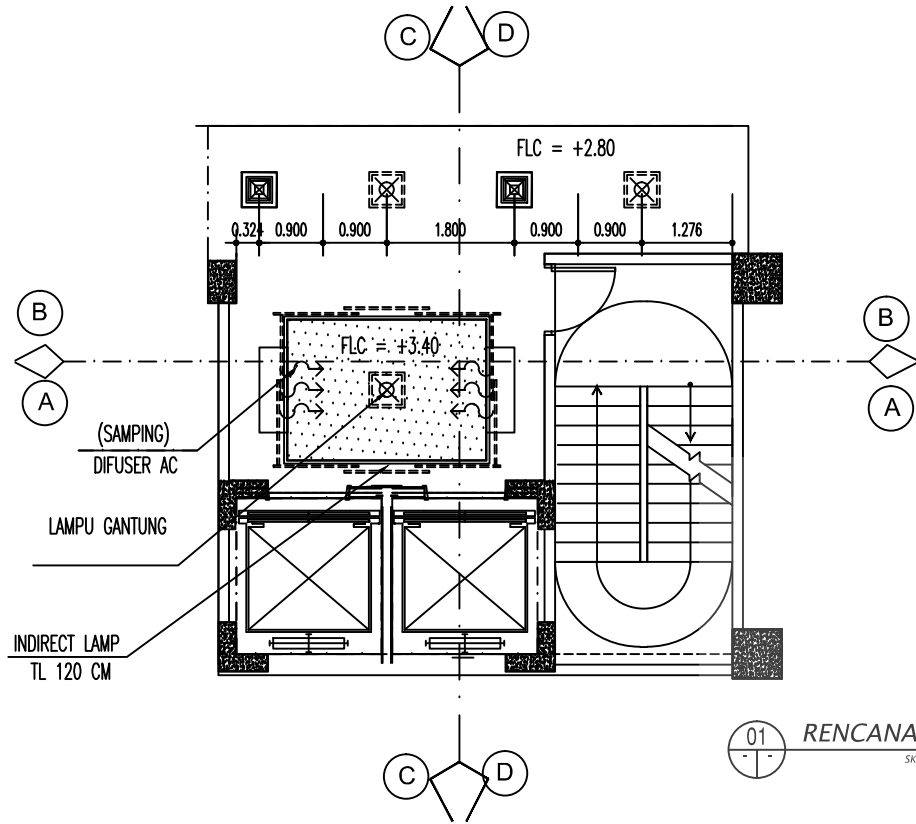

01 RENCANA POLA PLAFOND
SKALA: 1 : 100

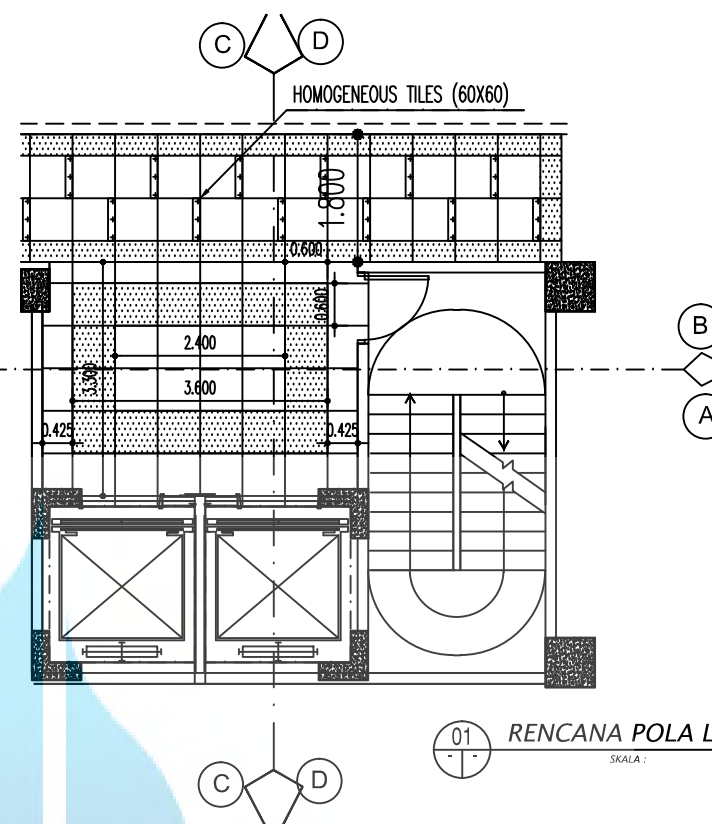

01 RENCANA POLA LANTAI
SKALA: 1 : 100

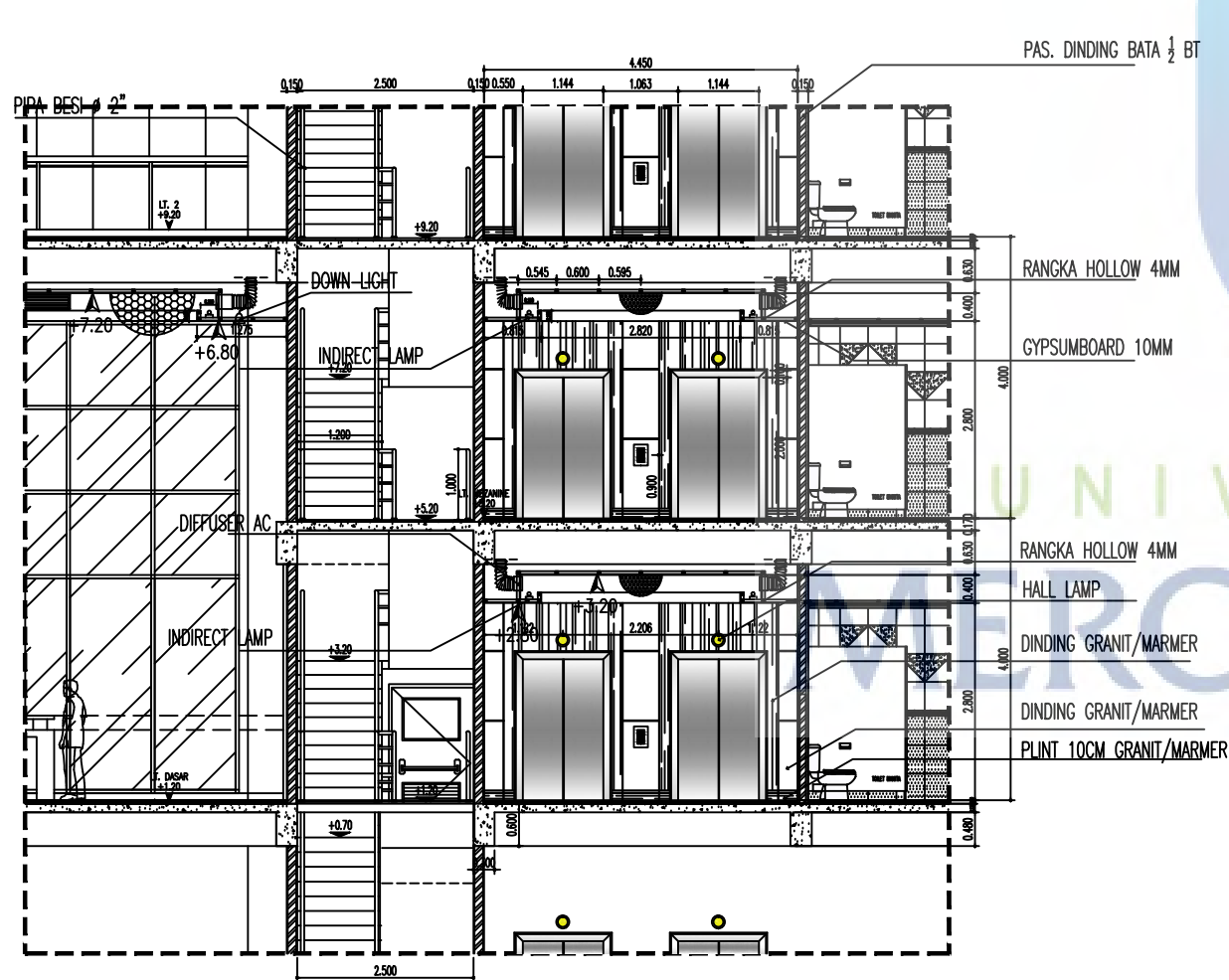

01 POTONGAN A-A'
SKALA: 1 : 100

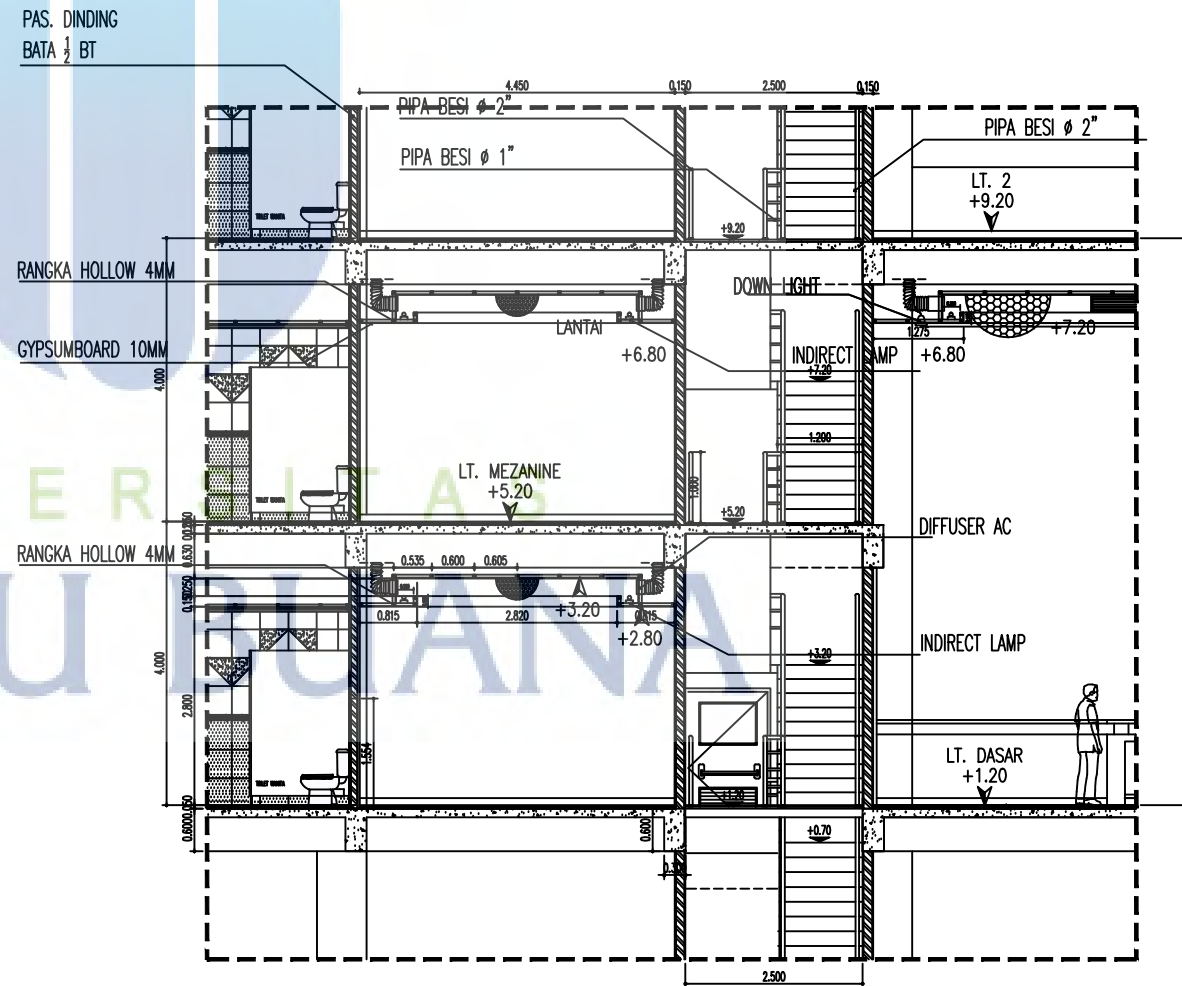

01 POTONGAN B-B'
SKALA: 1 : 100

CATATAN

NO	REVISI	TANGGAL PARAF

KEYPLAN

PROYEK

- OFFICE CIDENG -
JL. CIDENG BARAT 46D-47

OWNER/DEVELOPER

PANCA in HOUSE

KONSULTAN ARSITEK

TRENDRAMA
ARCHITECT
BENG_2001@YAHOO.COM

KONSULTAN STRUKTUR

SUYANDRA n PARTNERS
SIBP. 0005/P/KA/DPPB/V-2009
T. 021-65308047, E. suyandra@cbn.net.id

KONSULTAN ME

Mitra Perdana Engineering
Mechanical & Electrical Consultant
Perumahan Prima Indaya Blok 7/1, 4th Floor, Jakarta Barat - 1539
Phone : 021 5367399
Fax : 021 5367329
E-mail : mitra_perda@indosat.net.id / mpe_mitra@indosat.net.id

KONSULTAN LANSEKAP

KONTRAKTOR

JUDUL GAMBAR

DETAIL LOBBY TYPICAL LEMBAR 1

DIGAMBAR :	DIPERIKSA :	SKALA :
TANGGAL :	DISETUIJUI :	NO.REVISI :
NO. PROYEK :	NO. GAMBAR :	NO.LBR :
		A3-

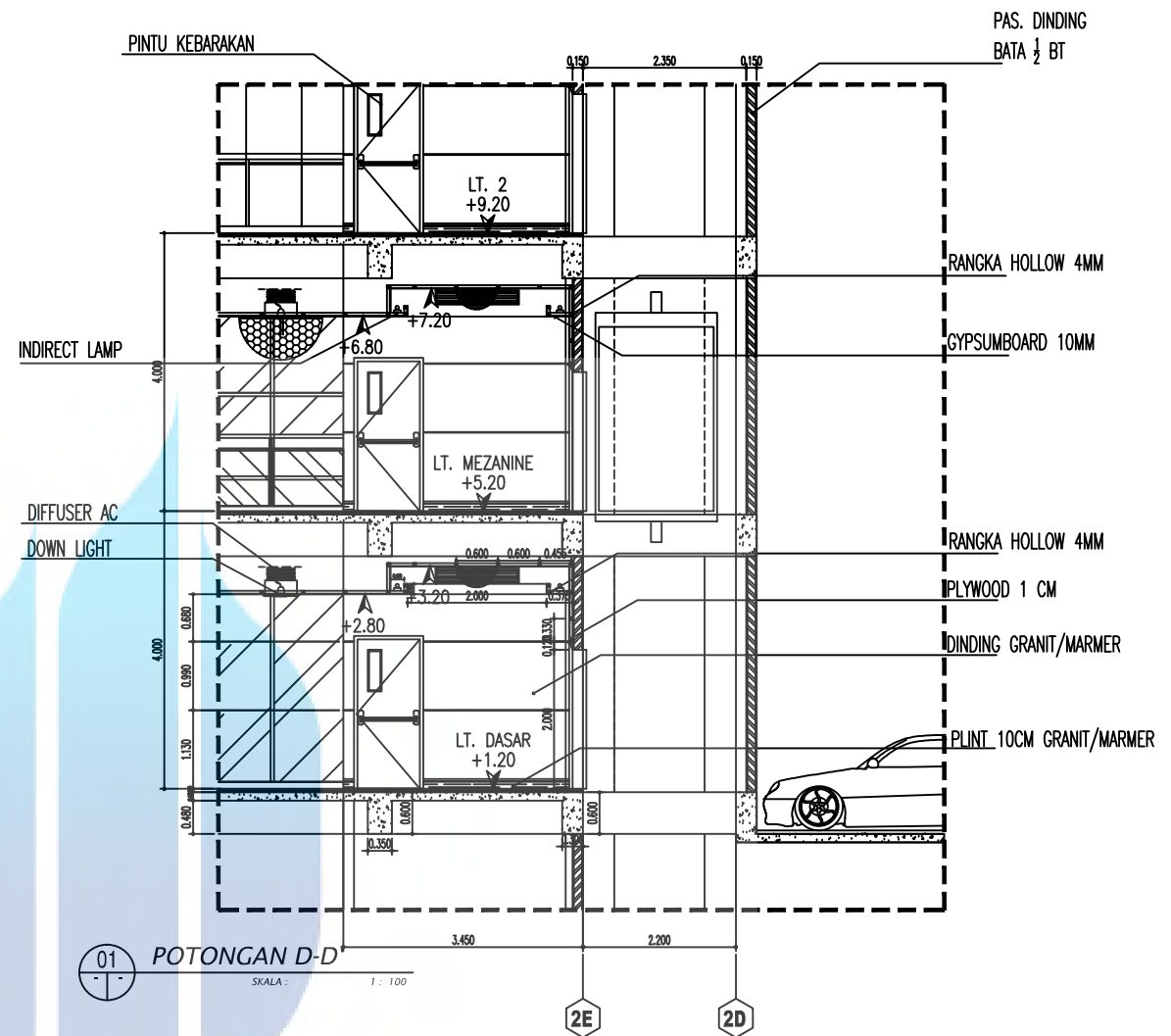
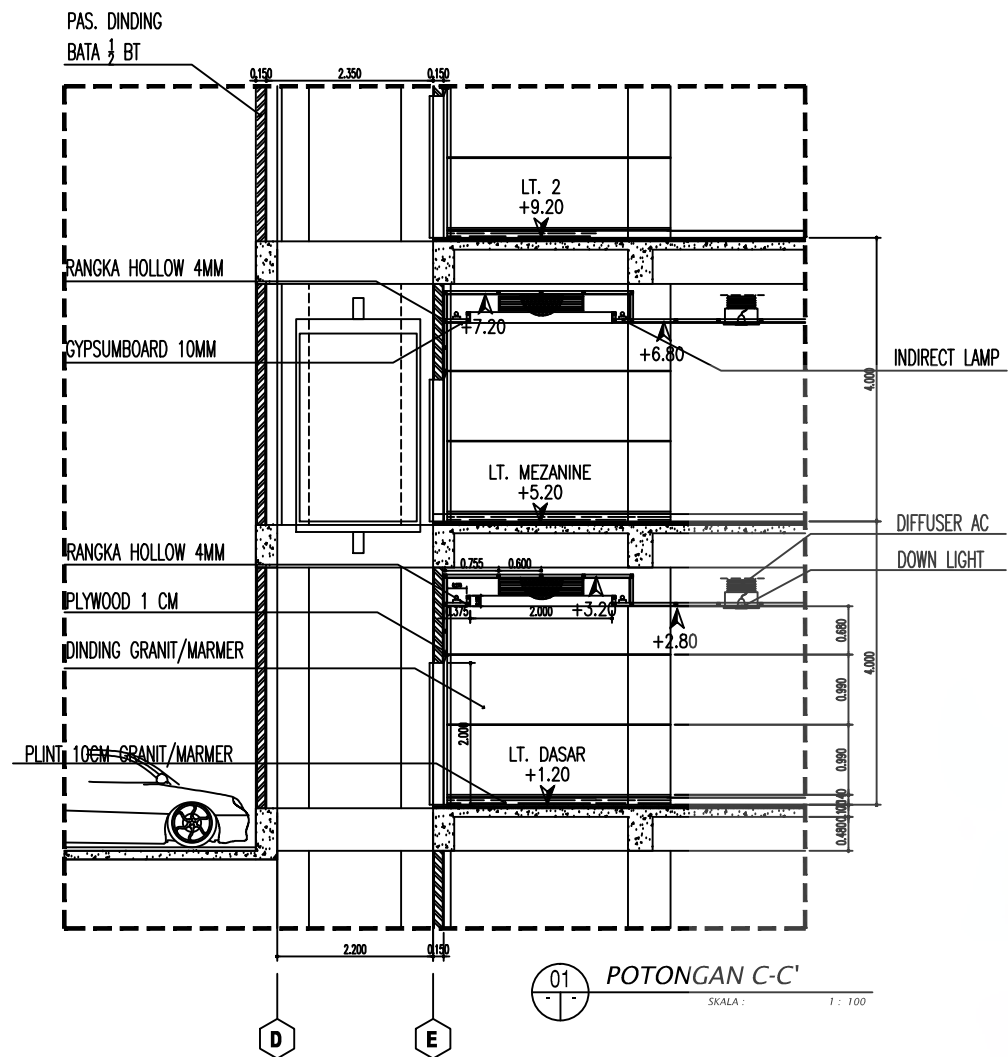

UNIVERSITAS
MERCU BUANA

CATATAN

NO	REVISI	TANGGAL PARAF

KEYPLAN

PROYEK

- OFFICE CIDENG -
JL. CIDENG BARAT 46D-47

OWNER/DEVELOPER

PANCA in HOUSE

KONSULTAN ARSITEK

TRENDRAMA
ARCHITECT
BENG_2001@YAHOO.COM

KONSULTAN STRUKTUR

SUYANDRA n PARTNERS
SIBP. 0005/P/KA/DPPB/V-2009
T. 021-65308047, E. suyandra@cbn.net.id

KONSULTAN ME

Mitra Perdana Engineering
Mechanical & Electrical Consultant
Perkantoran Prima Gedung Dind/4, 4th Floor, Jakarta Barat - 10330
Phone : 021 53627889
Fax : 021 5362789
E-mail : mitra_perda@hycom.com / mpe_mitraperdaind.com

KONSULTAN LANSEKAP

KONTRAKTOR

JUDUL GAMBAR

DETAIL LOBBY TYPICAL LEMBAR 2

DIGAMBAR :	DIPERIKSA :	SKALA :
-	-	1 : 1:100
TANGGAL :	DISETUJUI :	NO.REVISI :
-	-	-
NO. PROYEK	NO. GAMBAR	NO.LBR
		A3-

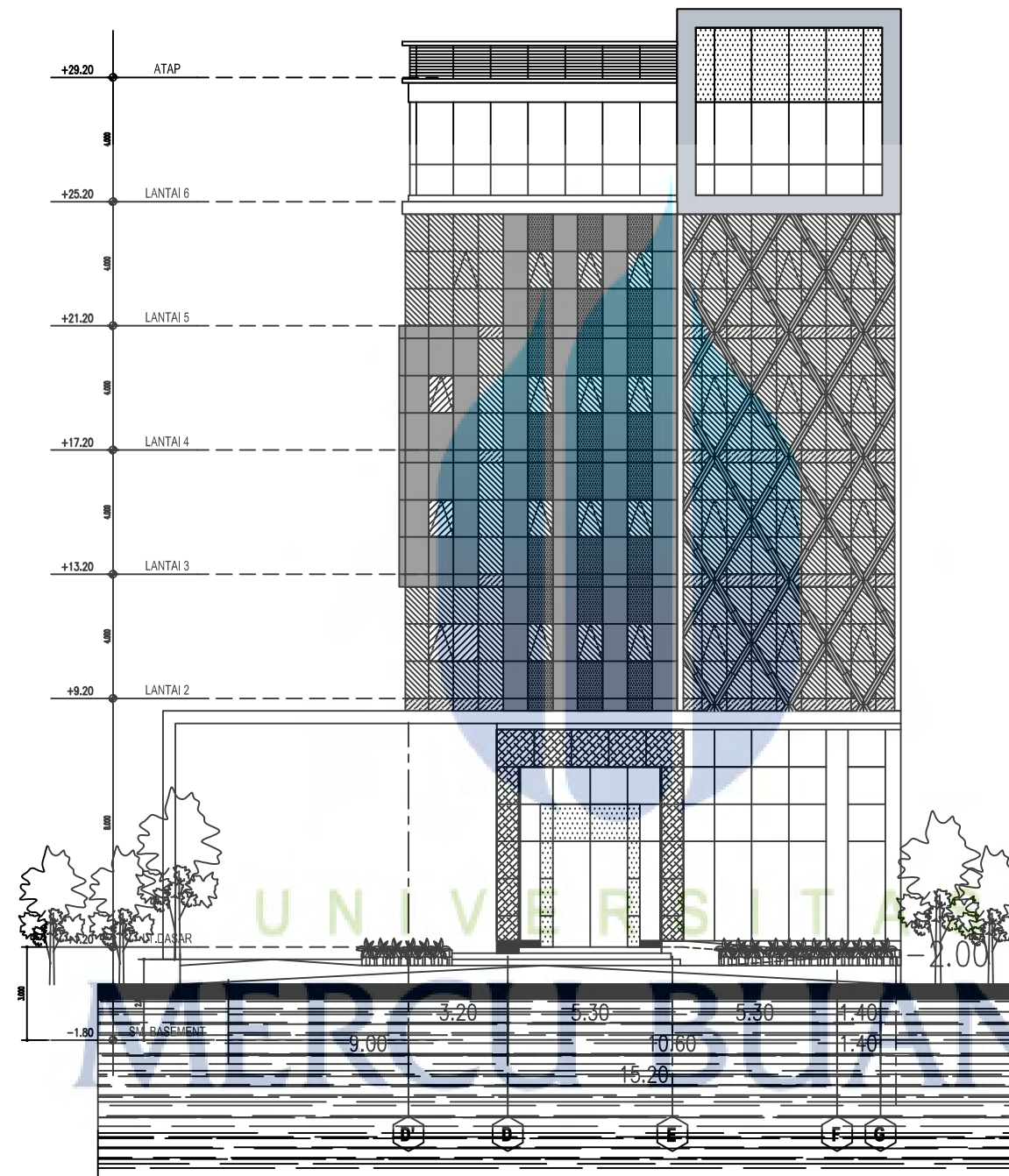

CATATAN

NO	REVISI	TANGGAL PARAF

KEYPLAN

PROYEK

- OFFICE CIDENG -
JL. CIDENG BARAT 46D-47

OWNER/DEVELOPER

PANCA in HOUSE

KONSULTAN ARSITEK

TRENDRAMA
ARCHITECT
BENG_2001@YAHOO.COM

KONSULTAN STRUKTUR

SUYANDRA n PARTNERS
SIBP. 0005/P/KA/DPPB/V-2009
T. 021-65308047, E. suyandra@cbn.net.id

KONSULTAN ME

Mitra Perdana Engineering
Mechanical & Electrical Consultant
Perkantoran Prima Karya Blok/F, 4th Floor, Jakarta Barat - 10330
Phone : 021 5367389
Fax : 021 5367329
E-mail : mitra_perda@hycom.com / mpe_mitraperdaing.com

KONSULTAN LANSEKAP

KONTRAKTOR

JUDUL GAMBAR

TAMPAK MUKA

DIGAMBAR :	DIPERIKSA :	SKALA :
-	-	1 : 1.200
TANGGAL :	DISETUJUI :	NO.REVISI :
-	-	-
NO. PROYEK	NO. GAMBAR	NO.LBR
AR-KHK-	AR-KHK-	A3 -

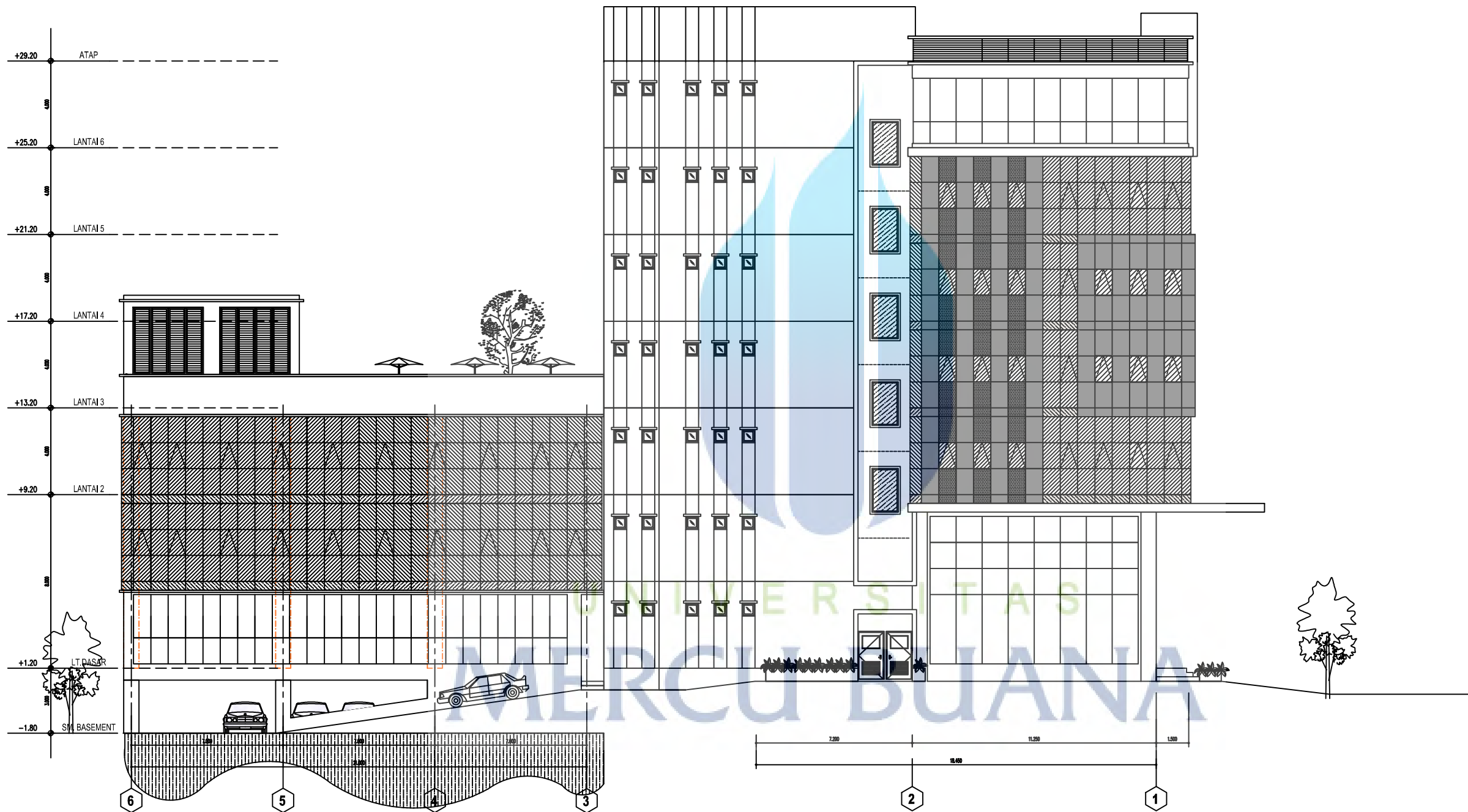

CATATAN

NO	REVISI	TANGGAL PARAF

KEYPLAN

PROYEK

- OFFICE CIDENG -
JL. CIDENG BARAT 46D-47

OWNER/DEVELOPER

PANCA in HOUSE

KONSULTAN ARSITEK

TRENDRAMA
ARCHITECT
BENG_2001@YAHOO.COM

KONSULTAN STRUKTUR

SUYANDRA n PARTNERS
SIBP. 0005/P/KA/DPPB/V-2009
T. 021-65308047, E. suyandra@cbn.net.id

KONSULTAN ME

Mitra Perdana Engineering
Mechanical & Electrical Consultant
Perumahan Prima Indah Blok 7/1, 4th Floor, Jakarta Barat - 1538
Phone : 021 5367389
Fax : 021 5367329
E-mail : mitra_perda@indosat.net.id / mpe_mitradp@gmail.com

KONSULTAN LANSEKAP

KONTRAKTOR

JUDUL GAMBAR

TAMPAK SAMPING KIRI

DIGAMBAR :	DIPERIKSA :	SKALA :
-	-	1 : 1 : 200
TANGGAL :	DISETUJUI :	NO.REVISI :
-	-	-
NO. PROYEK	NO. GAMBAR	NO.LBR
		A3 -

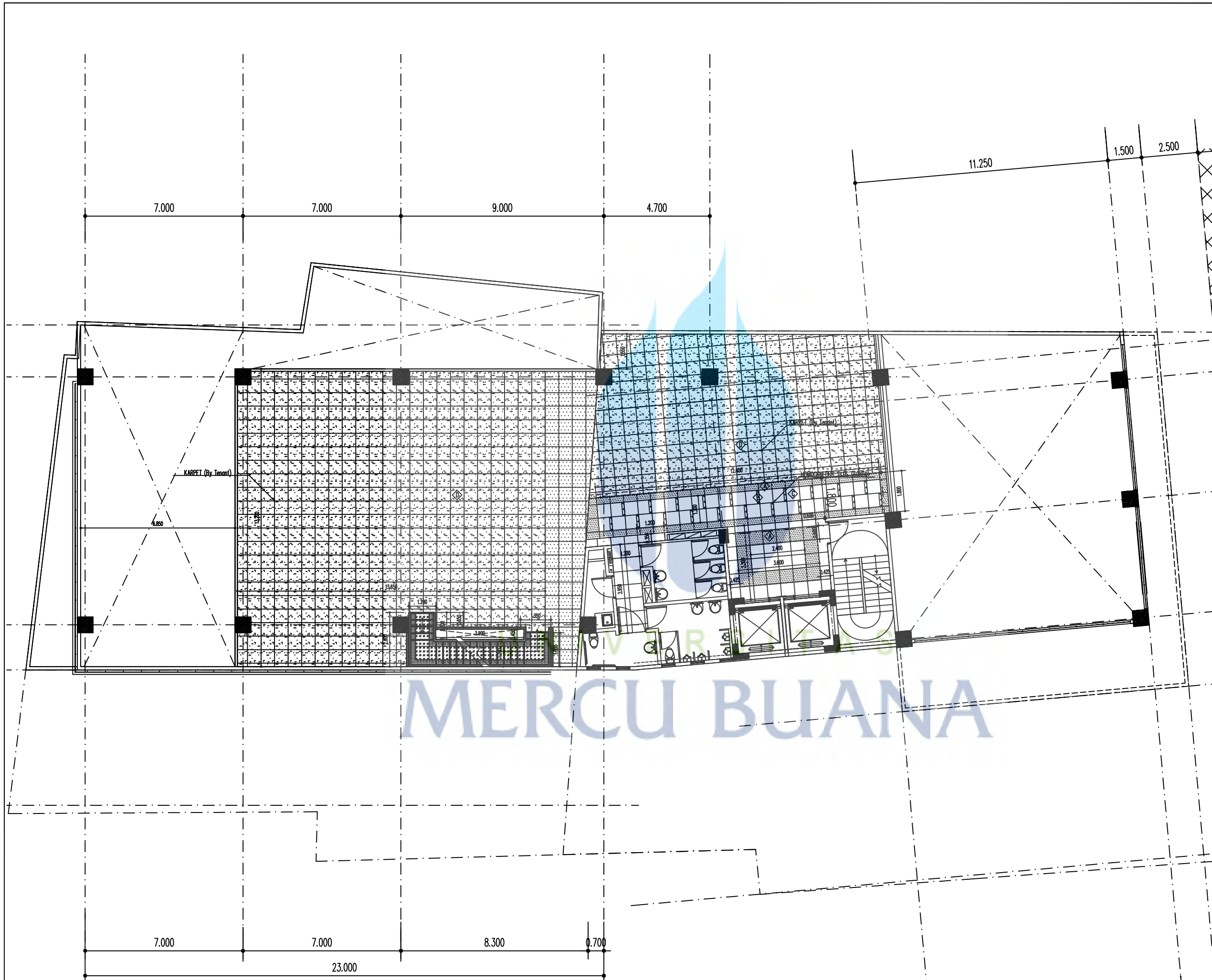

CATATAN		
◊	HOMOGENEOUS TILES 60 x 60	
◊	HOMOGENEOUS TILES 60 x 60	
◊	HOMOGENEOUS TILES 60 x 60	
◊	KARPET (By Tenant)	
◊	GRANIT	
◊	GRANIT	
◊	GRANIT	
NO	REVISI	TANGGAL PARAF
KEYPLAN		
PROYEK		
- OFFICE CIDENG -		
JL. CIDENG BARAT 46D-47		
OWNER/DEVELOPER		
PANCA in HOUSE		
KONSULTAN ARSITEK		
TRENDRAMA ARCHITECT BENG_2001@YAHOO.COM		
KONSULTAN STRUKTUR		
SUYANDRA n PARTNERS SIBP. 0005/P/KA/DPPB/V-2009 T. 021-65308047, E suyandra@cbn.net.id		
KONSULTAN ME		
 Mitra Perdana Engineering Mechanical & Electrical Consultant Perkantoran Prima Indya Blok IV, 4th Floor, Jember Barat - 65131 Phone : 0325 5367389 Fax : 0325 5367329 E-mail : mitra_perdana@ymail.com / mpe_mitra@ymail.com		
KONSULTAN LANSEKAP		
KONTRAKTOR		
JUDUL GAMBAR		
DENAH POLA LANTAI MEZANIN		
DIGAMBAR :	DIPERIKSA :	SKALA :
-	-	1 : 1:150
TANGGAL :	DISETUJUI :	NO.REVISI :
-	-	-
NO. PROYEK	NO. GAMBAR	NO.LBR
		A3 -

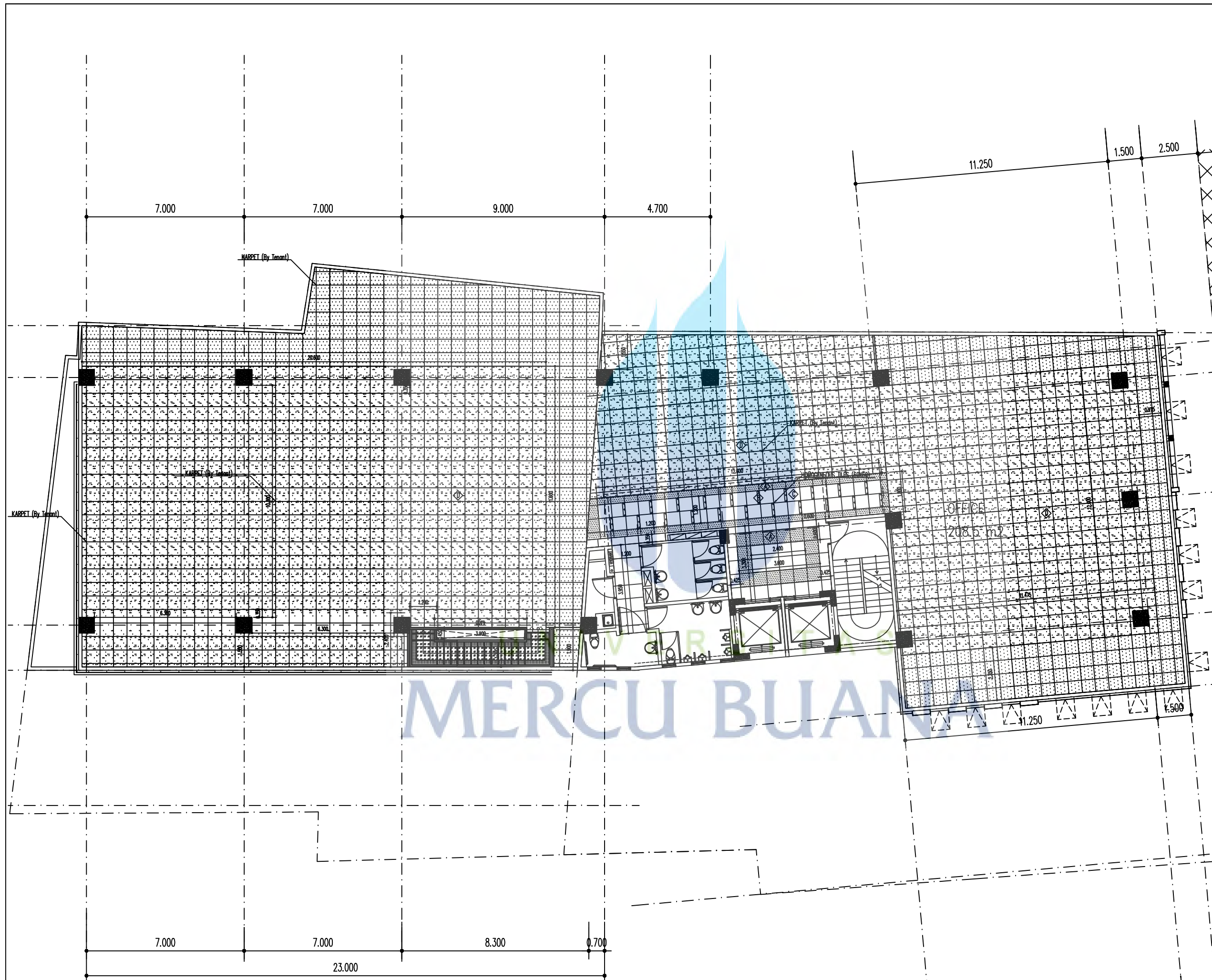

CATATAN		
◊	HOMOGENOUS TILES 60 x 60	
◊	HOMOGENOUS TILES 60 x 60	
◊	HOMOGENOUS TILES 60 x 60	
◊	KARPET (By Tenant)	
◊	GRANIT	
◊	GRANIT	
◊	GRANIT	
NO	REVISI	TANGGAL PARAF
KEYPLAN		
PROYEK		
- OFFICE CIDENG -		
JL. CIDENG BARAT 46D-47		
OWNER/DEVELOPER		
PANCA in HOUSE		
KONSULTAN ARSITEK		
TRENDRAMA ARCHITECT BENG_2001@YAHOO.COM		
KONSULTAN STRUKTUR		
SUYANDRA n PARTNERS SIBP. 0005/P/KA/DPPB/V-2009 T. 021-65308047, E. suyandra@cbn.net.id		
KONSULTAN ME		
 Mitra Perdana Engineering Mechanical & Electrical Consultant Perkantoran Prima Indaya Blok IV, 4th Floor, Jakarta Barat - 10310 Phone : 021 5367389 Fax : 021 5367329 E-mail : mitra_perdana@hytel.com / mpe_mitrampe@gmail.com		
KONSULTAN LANSEKAP		
KONTRAKTOR		
JUDUL GAMBAR		
DENAH POLA LANTAI DUA		
DIGAMBAR :	DIPERIKSA :	SKALA :
-	-	1 : 1:150
TANGGAL :	DISETUJUI :	NO.REVISI :
-	-	-
NO. PROYEK	NO. GAMBAR	NO.LBR
		A3 -

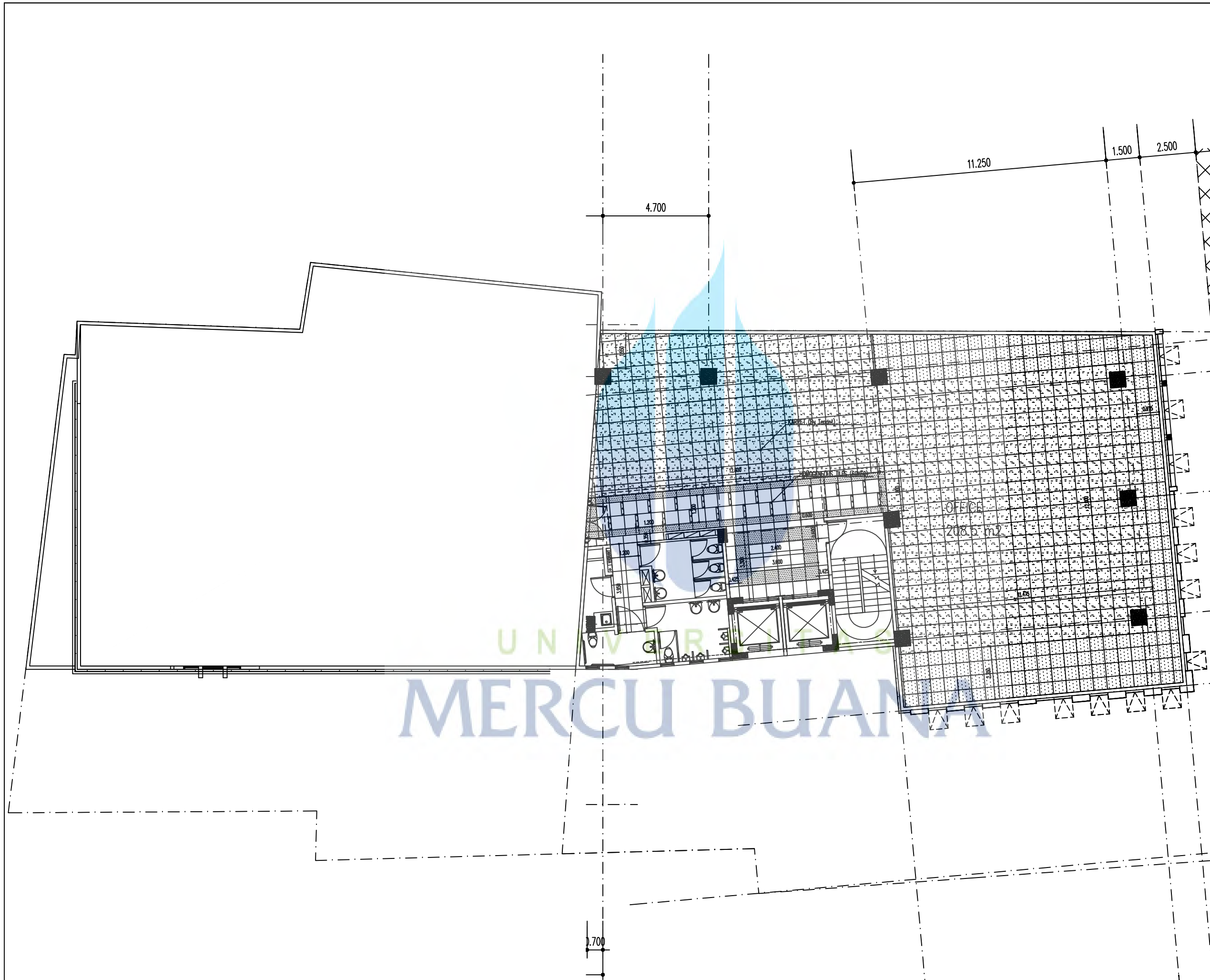

CATATAN

- ◊ HOMOGENEOUS TILES 60 x 60
- ◊ HOMOGENEOUS TILES 60 x 60
- ◊ HOMOGENEOUS TILES 60 x 60
- ◊ KARPET (By Tenant)
- ◊ GRANIT
- ◊ GRANIT
- ◊ GRANIT

NO	REVISI	TANGGAL PARAF

KEYPLAN

PROYEK

- OFFICE CIDENG -
 JL. CIDENG BARAT 46D-47

OWNER/DEVELOPER

PANCA in HOUSE

KONSULTAN ARSITEK

TRENDRAMA
 ARCHITECT
 BENG_2001@YAHOO.COM

KONSULTAN STRUKTUR

SUYANDRA n PARTNERS
 SIBP. 0005/P/KA/DPPB/V-2009
 T. 021-65308047, E. suyandra@cbn.net.id

KONSULTAN ME

Mitra Perdana Engineering
 Mechanical & Electrical Consultant
 Perkantoran Prima Indaya Blok/1, 4th Floor, Jakarta Barat - 1039
 Phone : 021 5367389
 Fax : 021 5367329
 E-mail : mitra_perda@hynd.com / mpe_mitradp@ind.com

KONSULTAN LANSEKAP

KONTRAKTOR

JUDUL GAMBAR

DENAH POLA LANTAI TIGA

DIGAMBAR :	DIPERIKSA :	SKALA :
-	-	1 : 1:150
TANGGAL :	DISETUJUI :	NO.REVISI :
-	-	-
NO. PROYEK	NO. GAMBAR	NO.LBR
		A3 -

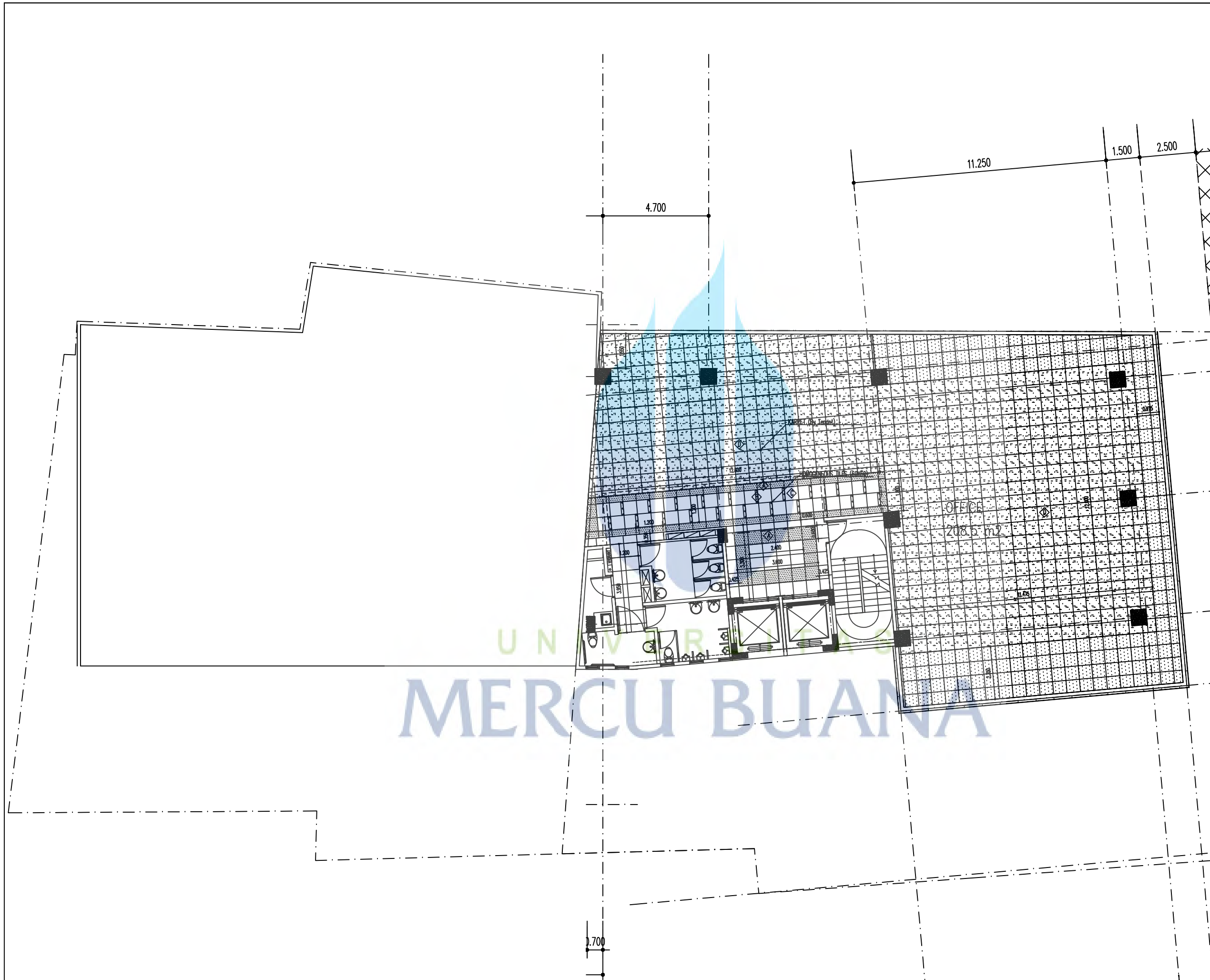

CATATAN

- ◊ HOMOGENEOUS TILES 60 x 60
- ◊ HOMOGENEOUS TILES 60 x 60
- ◊ HOMOGENEOUS TILES 60 x 60
- ◊ KARPET (By Tenant)
- ◊ GRANIT
- ◊ GRANIT
- ◊ GRANIT

NO	REVISI	TANGGAL PARAF

KEYPLAN

PROYEK

- OFFICE CIDENG -
 JL. CIDENG BARAT 46D-47

OWNER/DEVELOPER

PANCA in HOUSE

KONSULTAN ARSITEK

TRENDRAMA
 ARCHITECT
 BENG_2001@YAHOO.COM

KONSULTAN STRUKTUR

SUYANDRA n PARTNERS
 SIBP. 0005/P/KA/DPPB/V-2009
 T. 021-65308047, E. suyandra@cbn.net.id

KONSULTAN ME

Mitra Perdana Engineering
 Mechanical & Electrical Consultant
 Perkantoran Prima Indaya Blok/1, 4th Floor, Jakarta Barat - 10530
 Phone : 021 5367389
 Fax : 021 5367329
 E-mail : mitra_perdana@ymail.com / mpe_mitraperdana@gmail.com

KONSULTAN LANSEKAP

KONTRAKTOR

JUDUL GAMBAR

DENAH POLA LANTAI 4-5

DIGAMBAR :	DIPERIKSA :	SKALA :
-	-	1 : 1:150
TANGGAL :	DISETUIJUI :	NO.REVISI :
-	-	-
NO. PROYEK	NO. GAMBAR	NO.LBR
		A3-

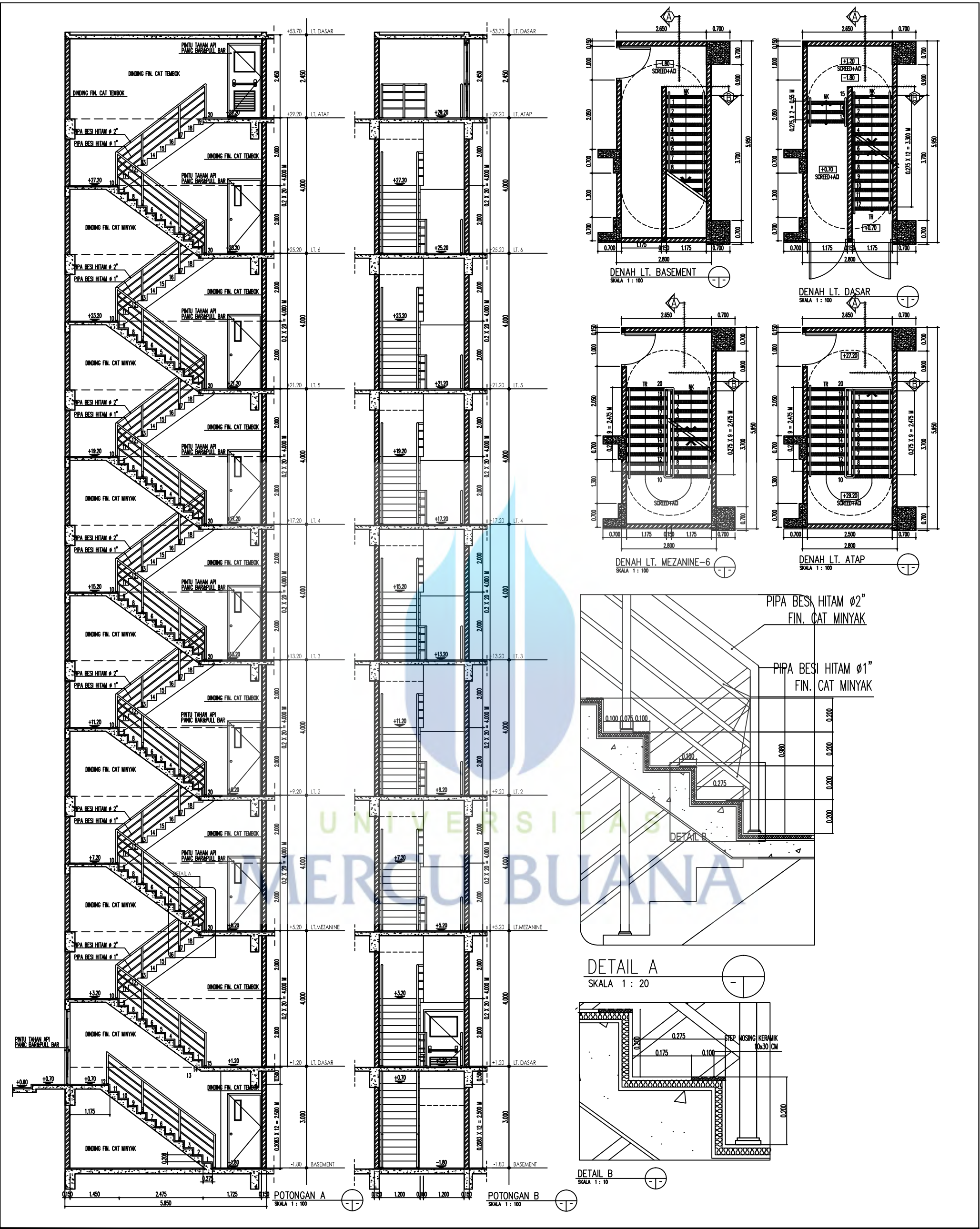

CATATAN			
NO.	REVISI	TANGGAL PARAF	
KEVLAN PROJEK - OFFICE CIDENG -			
PANCA in HOUSE KONSULTAN ARSITEK TRENDRAMA ARCHITECT BRNO.2001@VAHO.COM			
KONSULTAN STRUKTUR SUYANDRA n PARTNERS T. 021-65308047, E. suyondra@chn.net.id			
KONSULTAN ME Mitra Perdana Engineering Jl. Jendral Sudirman No. 171, Jakarta Selatan - 12165 Telp : 021 5213225 Email : mitra_perdana@mp-engineering.com			
KONSULTAN LANSKAP PT. MERCU BUANA			
KONTRAKTOR DETAIL TANGGA KEBAKARAN			
JUDUL GAMBAR DETAIL TANGGA KEBAKARAN			
GAMBAR : DIBERIKSA : TANGGAL : DIBERIKSA : NO. REVISI : NO. GAMBAR : NOLIBR : A3-			

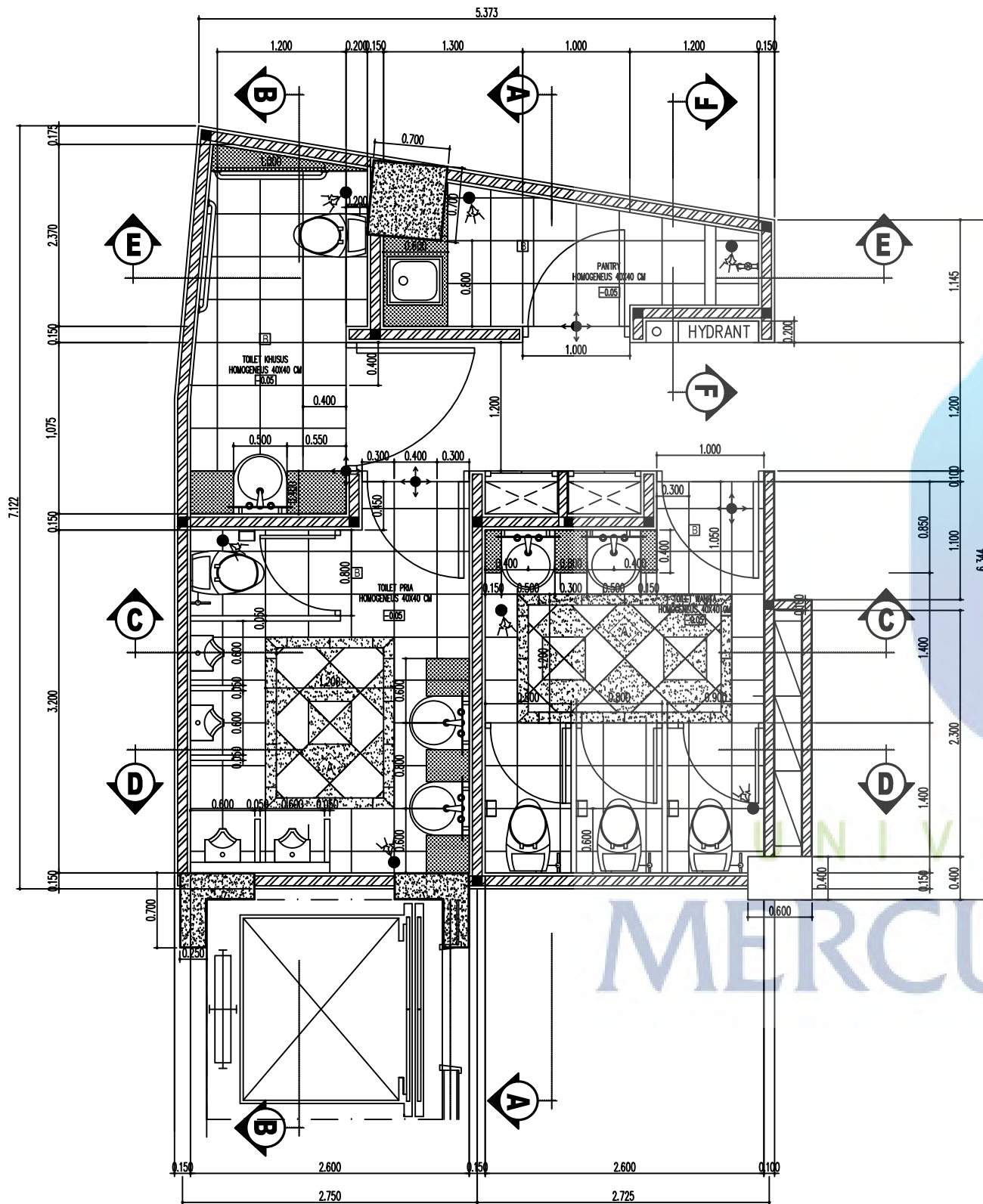

DENAH TOILET
SKALA 1:50

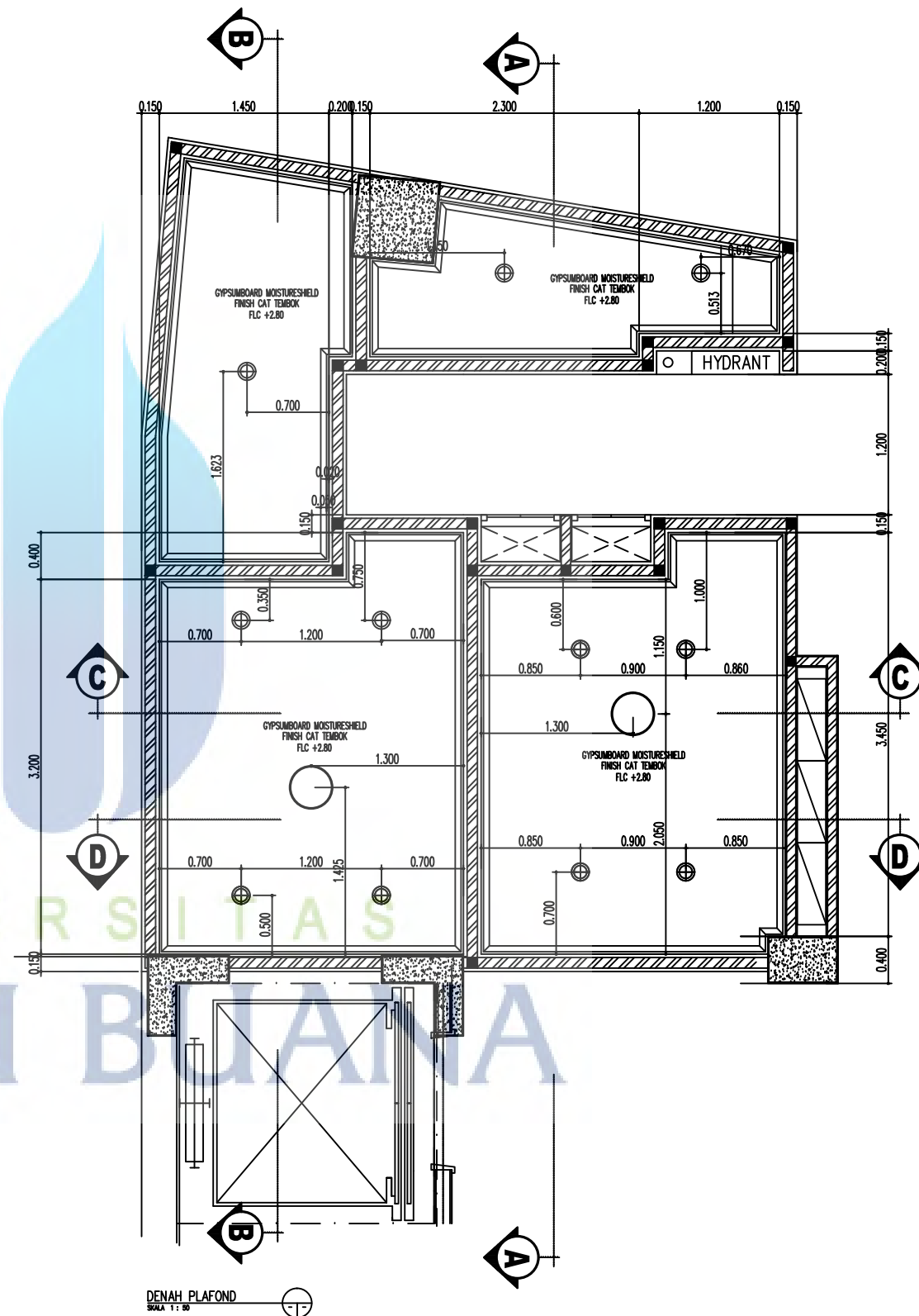

DENAH PLAFOND
SKALA 1:50

CATATAN

- LEGENDA :
- ⊙ = DOWNLIGHT
 - ⊕ = LAMPU HAS
 - ⊛ = START POM KERAMIK
 - ⊠ = HOMOGENEUS 40 X 40 TPE 1
 - ⊡ = HOMOGENEUS 40 X 40 TPE 2
 - ⊞ = HOMOGENEUS 40 X 40 TPE 1
 - ⊟ = HOMOGENEUS 40 X 40 TPE 2

NO	REVISI	TANGGAL PARAF

KEYPLAN
 PROYEK
- OFFICE CIDENG -
 JL. CIDENG BARAT 46D-47

OWNER/DEVELOPER
PANCA in HOUSE

KONSULTAN ARSITEK
TRENDRAMA
 ARCHITECT
 BENG_2001@YAHOO.COM

KONSULTAN STRUKTUR
SUYANDRA n PARTNERS
 SIBP. 0005/P/KA/DPPB/V-2009
 T. 021-65308047, E. suyandra@cbn.net.id

KONSULTAN ME

Mitra Perdana Engineering
 Mechanical & Electrical Consultant
 Purbasari Prima Indya Blok/3, 4th Floor, Jakarta Barat - 1539
 Phone : 021 5267289
 Fax : 021 5267289
 E-mail : mitra_perda@system.com / mpe_mitra@ptd.com

KONSULTAN LANSEKAP

KONTRAKTOR

JUDUL GAMBAR
DENAH DAN RENCANA PLAFOND

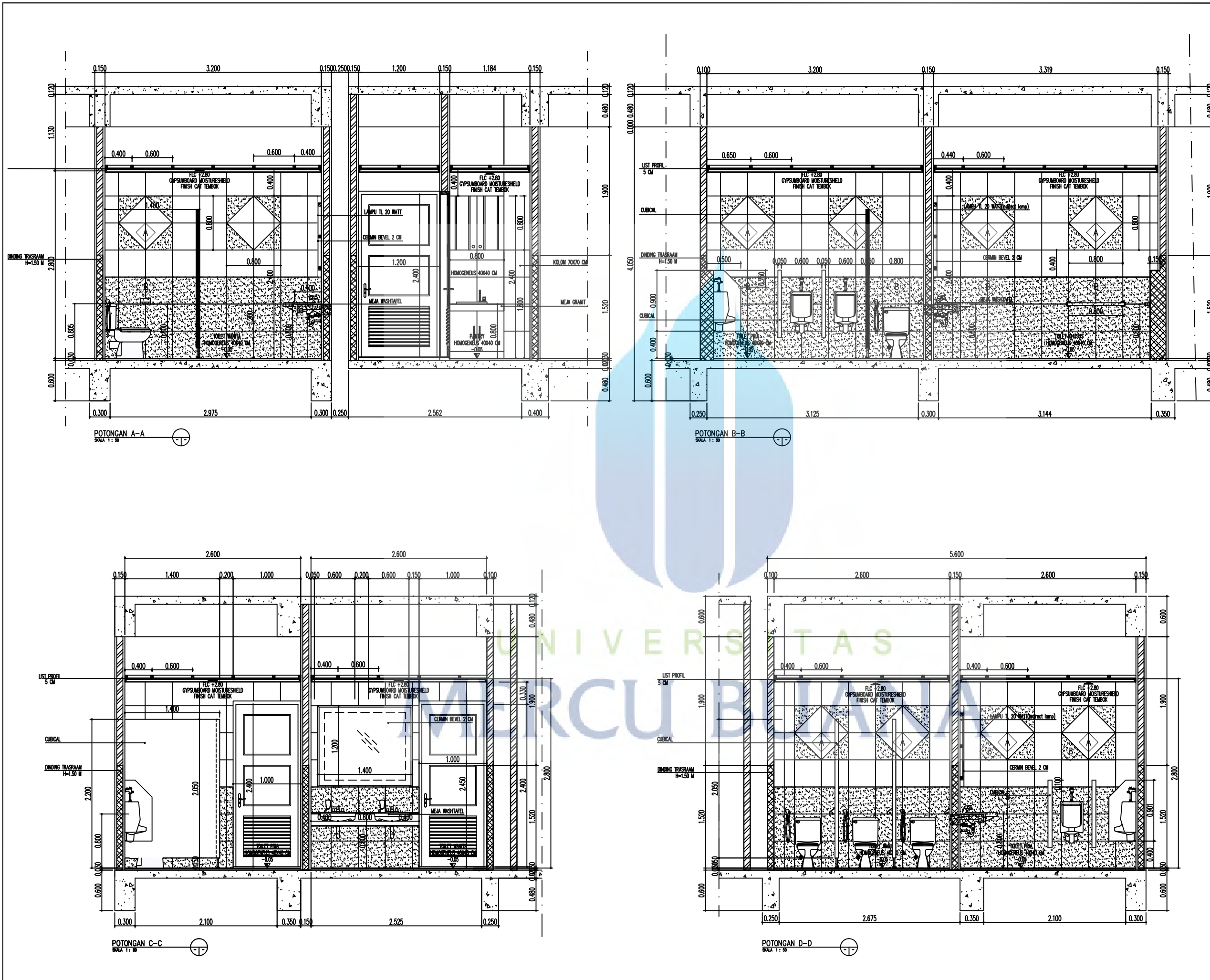
DIGAMBAR :	DIPERIKSA :	SKALA :
TANGGAL :	DISETUJUI :	NO.REVISI :
NO. PROYEK	NO. GAMBAR	NO.LBR
		A3-



CATATAN		
LEGENDA : ○ = DOWNLIGHT ⊙ = LAMPU HAS ⊕ = START POND KERAMIK ◊ = HOMOGENEUS 40 X 40 TPE 1 ⊠ = HOMOGENEUS 40 X 40 TPE 2 ⊡ = HOMOGENEUS 40 X 40 TPE 1 ⊢ = HOMOGENEUS 40 X 40 TPE 2		
NO	REVISI	TANGGAL PARAF
KEYPLAN		
PROYEK		
- OFFICE CIDENG -		
JL. CIDENG BARAT 46D-47		
OWNER/DEVELOPER		
PANCA in HOUSE		
KONSULTAN ARSITEK		
TRENDRAMA ARCHITECT BENG_2001@YAHOO.COM		
KONSULTAN STRUKTUR		
SUYANDRA n PARTNERS SIBP. 0005/P/KA/DPPB/V-2009 T. 021-65308047, E. suyandra@cbn.net.id		
KONSULTAN ME		
 Mitra Perdana Engineering Mechanical & Electrical Consultant Perkantoran Prima Gedung Dindri, 4th Floor, Jakarta Barat - 1039 Phone : 021 5362789 Fax : 021 5362789 E-mail : mitra_perda@indosat.net.id / mpe_mitra@indosat.net.id		
KONSULTAN LANSEKAP		
KONTRAKTOR		
JUDUL GAMBAR		
POTONGAN TOILET		
DIGAMBAR :	DIPERIKSA :	SKALA :
TANGGAL :	DISETUIJUI :	NO. REVISI :
NO. PROYEK :	NO. GAMBAR :	NO. LBR :
		A3-

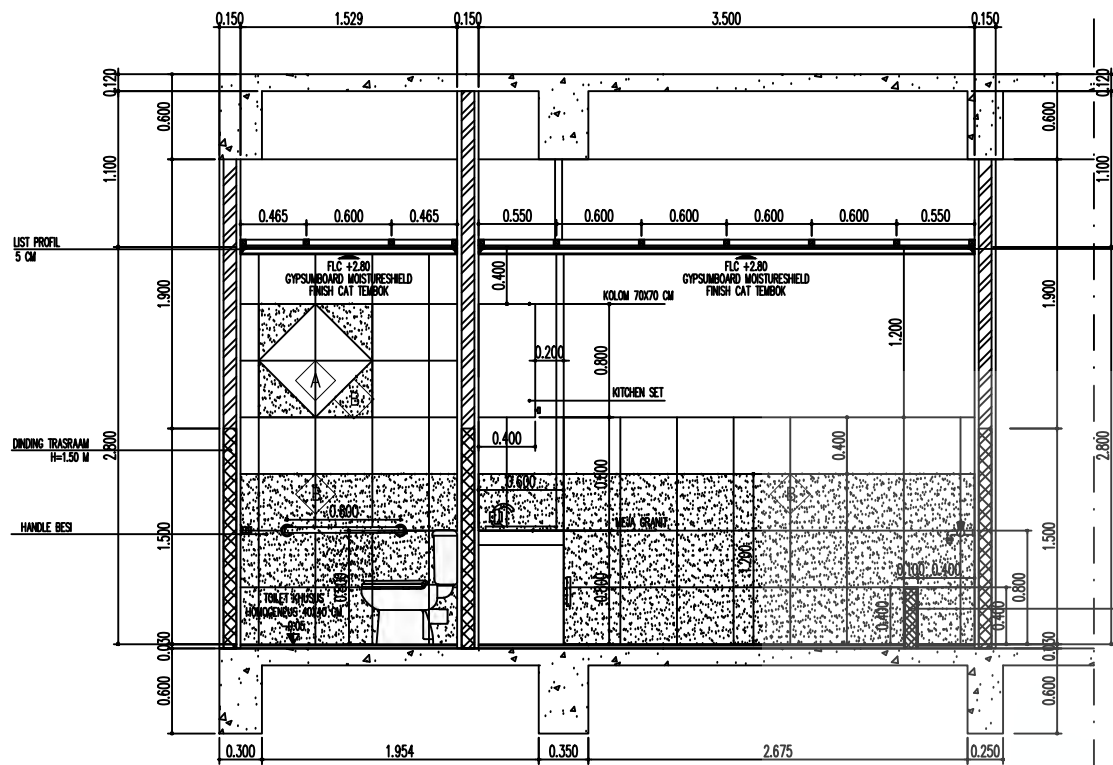

LIST KAYU
5 CM

DINDING TRASRAM
H=1.30 M

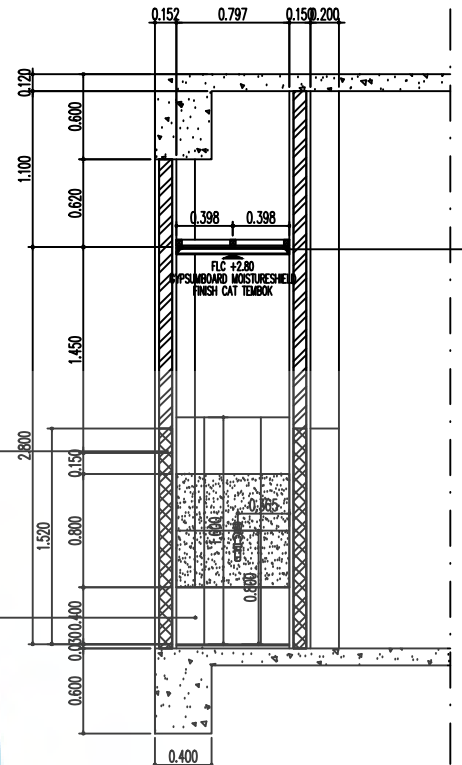

LIST PROFIL
5 CM

DINDING TRASRAM
H=1.50 M

DINDING KERAMIK
H=0.40 M

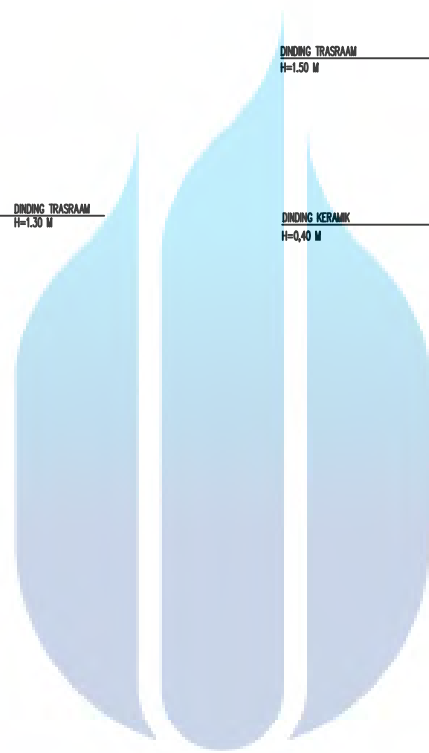

UNIVERSITAS
MERCU BUANA

CATATAN

- START PON KERAMIK
- HOMODENSUS 40 X 40 TPE 1
- HOMODENSUS 40 X 40 TPE 2
- HOMODENSUS 40 X 40 TPE 1
- HOMODENSUS 40 X 40 TPE 2

NO	REVISI	TANGGAL PARAF

KEYPLAN

PROYEK

- OFFICE CIDENG -
JL. CIDENG BARAT 46D-47

OWNER/DEVELOPER

PANCA in HOUSE

KONSULTAN ARSITEK

TRENDRAMA
ARCHITECT
BENG_2001@YAHOO.COM

KONSULTAN STRUKTUR

SUYANDRA n PARTNERS
SIBP. 0005/P/KA/DPPB/V-2009
T. 021-65308047, E. suyandra@cbn.net.id

KONSULTAN ME

Mitra Perdana Engineering
Mechanical & Electrical Consultant
Perumahan Prima Indaya Blok 7/1, 4th Floor, Jakarta Barat - 10530
Phone : 021 5367399
Fax : 021 5367329
E-mail : mitra_perda@mitraengine.com / mpe_mitraperdaing.com

KONSULTAN LANSEKAP

KONTRAKTOR

JUDUL GAMBAR

POTONGAN TOILET

DIGAMBAR :	DIPERIKSA :	SKALA :
-	-	1 : 1.50
TANGGAL :	DISETUJUI :	NO.REVISI :
-	-	-
NO. PROYEK	NO. GAMBAR	NO.LBR
		A3-

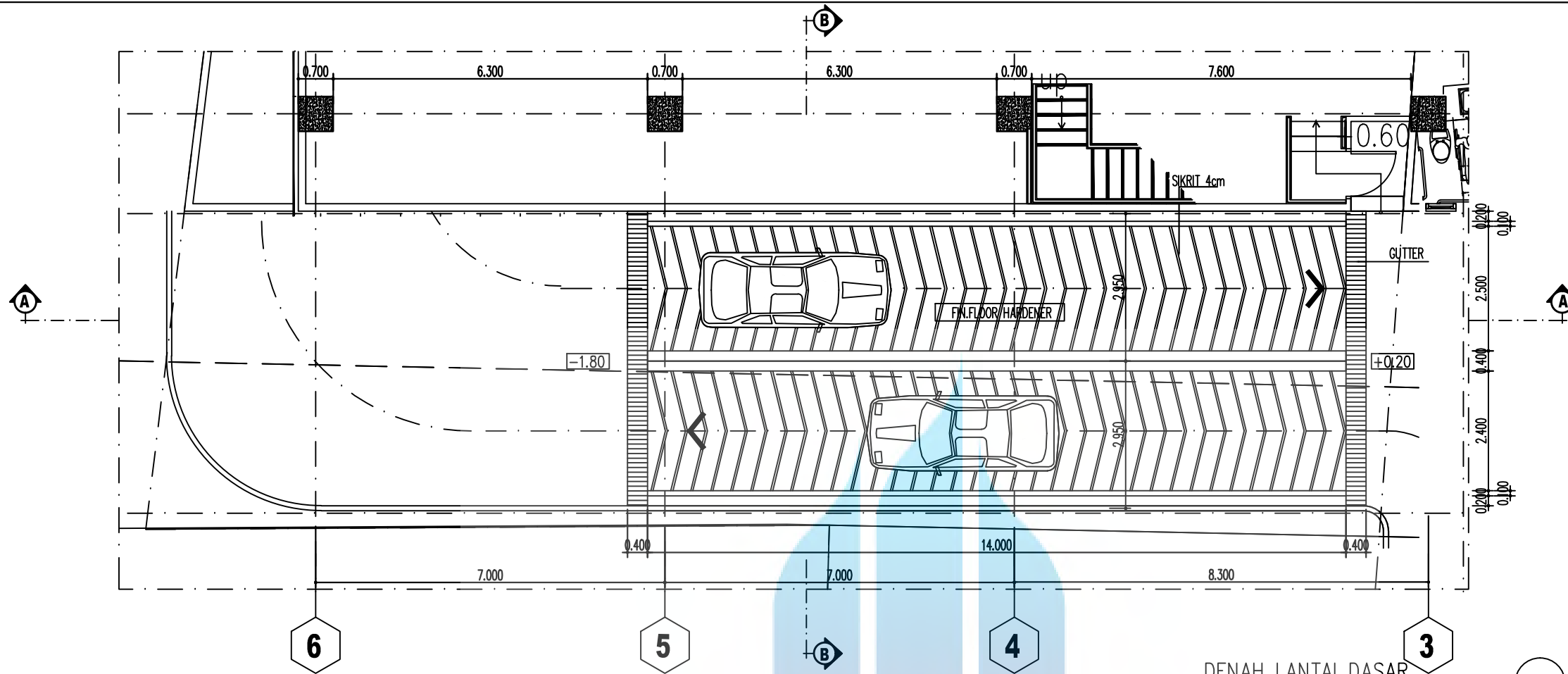

DENAH LANTAI DASAR
SKALA 1 : 50

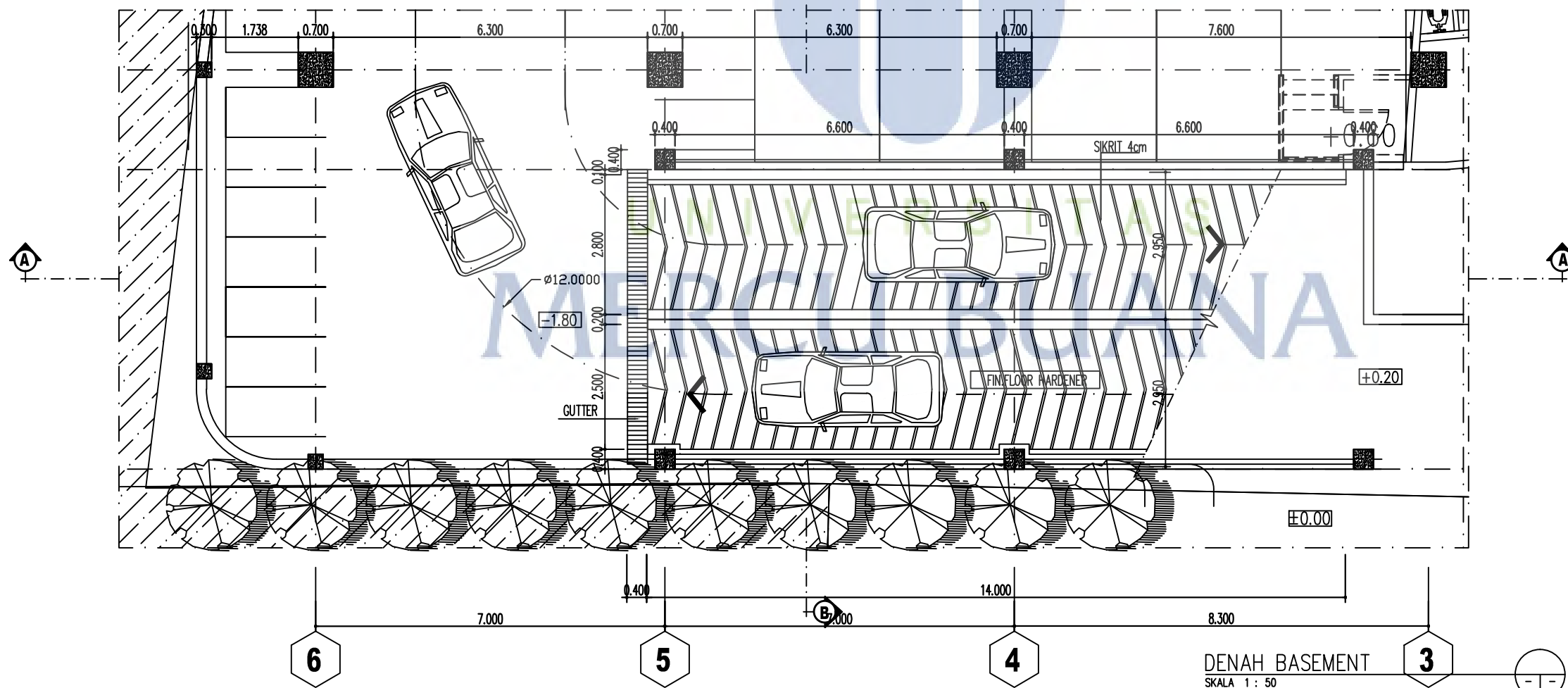

DENAH BASEMENT
SKALA 1 : 50

CATATAN		
LOKASI RAMP		
NO	REVISI	TANGGAL PARAF
KEYPLAN		
PROYEK		
- OFFICE CIDENG -		
JL. CIDENG BARAT 46D-47		
OWNER/DEVELOPER		
PANCA in HOUSE		
KONSULTAN ARSITEK		
TRENDRAMA ARCHITECT BENG_2001@YAHOO.COM		
KONSULTAN STRUKTUR		
SUYANDRA n PARTNERS SIBP. 0005/P/KA/DPPB/V-2009 T. 021-65308047, E. suyandra@cbn.net.id		
KONSULTAN ME		
 Mitra Perdana Engineering Mechanical & Electrical Consultant Perkantoran Prima Indaya Blok IV, 4th Floor, Jakarta Barat - 10310 Phone : 021 5367389 Fax : 021 5367329 E-mail : mitra_perdana@indosat.net.id / mpe_mitra@indosat.net.id		
KONSULTAN LANSEKAP		
KONTRAKTOR		
JUDUL GAMBAR		
DETAIL RAMP LEMBAR 1		
DIGAMBAR :	DIPERIKSA :	SKALA :
TANGGAL :	DISETUIJUI :	NO.REVISI :
NO. PROYEK	NO. GAMBAR	NO.LBR
		A3-

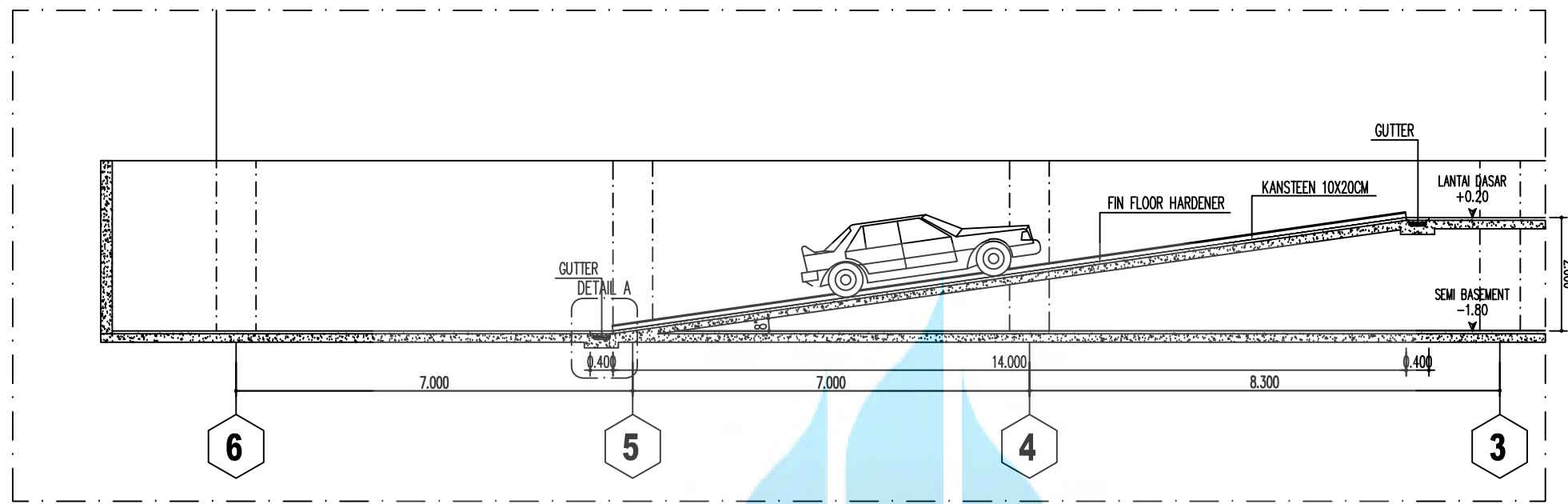

POTONGAN A.A
SKALA 1 : 50

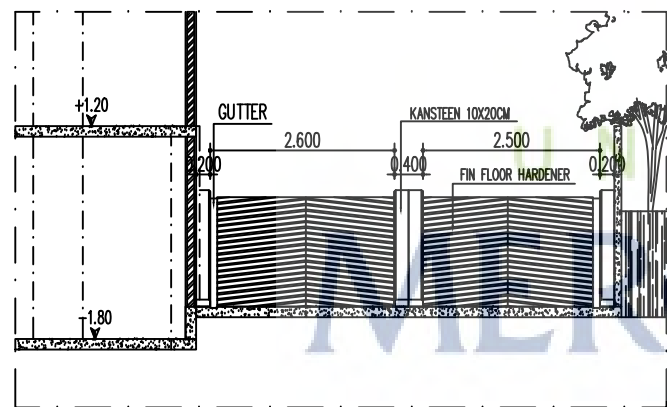

POTONGAN B.B
SKALA 1 : 50

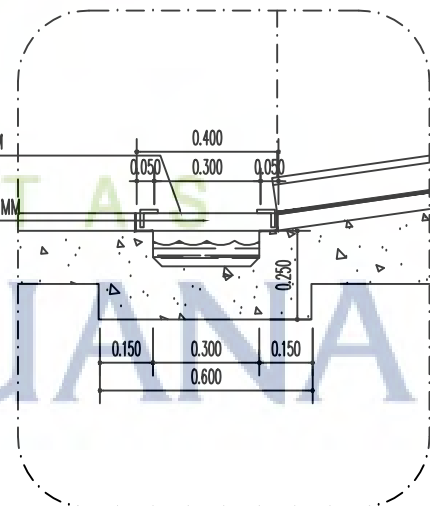

DETAIL A
SKALA 1 : 10

CATATAN

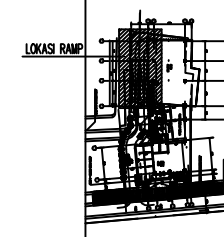

NO	REVISI	TANGGAL PARAF

KEYPLAN

PROYEK

- OFFICE CIDENG -
JL. CIDENG BARAT 46D-47

OWNER/DEVELOPER

PANCA in HOUSE

KONSULTAN ARSITEK

TRENDRAMA
ARCHITECT
BENG_2001@YAHOO.COM

KONSULTAN STRUKTUR

SUYANDRA n PARTNERS
SIBP. 0005/P/KA/DPPB/V-2009
T. 021-65308047, E. suyandra@cbn.net.id

KONSULTAN ME

Mitra Perdana Engineering
Mechanical & Electrical Consultant
Perkantoran Prima Gedung Dik/7, 4th Floor, Jakarta Barat - 10330
Phone : 021 5367389
Fax : 021 5367329
E-mail : mitra_perdana@mitra_perdana.com

KONSULTAN LANSEKAP

KONTRAKTOR

JUDUL GAMBAR

DETAIL RAMP LEMBAR 2

DIGAMBAR :	DIPERIKSA :	SKALA :
-	-	1 : 1.50
TANGGAL :	DISETUIJUI :	NO.REVISI :
-	-	-
NO. PROYEK	NO. GAMBAR	NO.LBR
		A3-

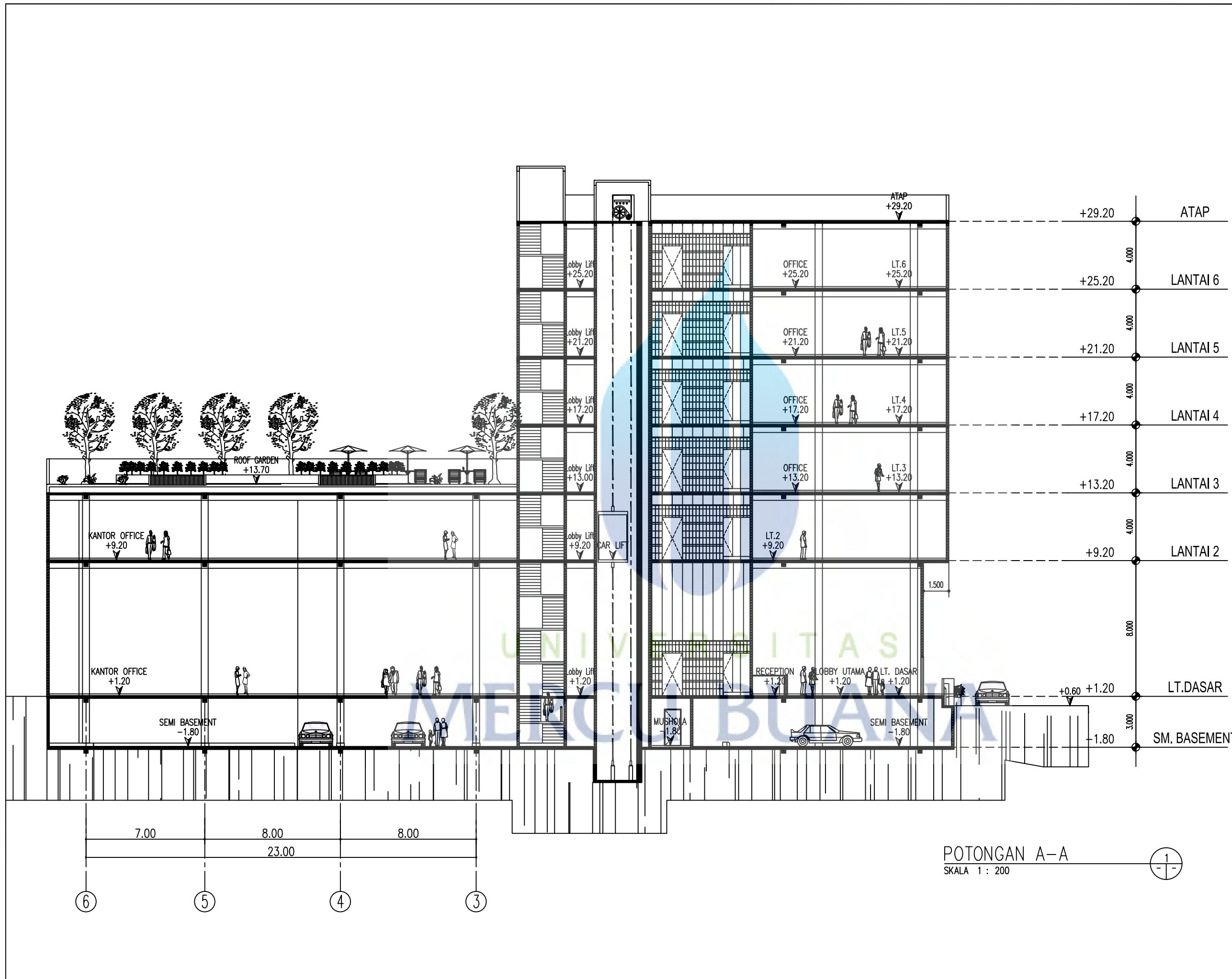

POTONGAN A-A
SKALA 1 : 200

CATATAN		
NO	REVISI	TANGGAL PARAF
KEYPLAN		
PROYEK		
- OFFICE CIDENG -		
JL. CIDENG BARAT 46D-47		
OWNER/DEVELOPER		
PANCA in HOUSE		
KONSULTAN ARSITEK		
TRENDRAMA ARCHITECT BENG_2001@YAHOO.COM		
KONSULTAN STRUKTUR		
SUYANDRA n PARTNERS SIBP. 0005/P/KA/DPPB/V-2009 T. 021-65308047, E. suyandra@cbn.net.id		
KONSULTAN ME		
 Mitra Perdana Engineering Mechanical & Electrical Consultant Perumahan Prima Sunda Dik/7, 4th Floor, Jember Barat - 65319 Phone : 021 5307589 Fax : 021 5307525 E-mail : mitra_perma@indosat.net.id / mpe_mitra@indosat.net.id		
KONSULTAN LANSEKAP		
KONTRAKTOR		
JUDUL GAMBAR		
POTONGAN A-A		
DIGAMBAR :	DIPERIKSA :	SKALA :
-	-	1 : 1:200
TANGGAL :	DISETUI :	NO.REVISI :
-	-	-
NO. PROYEK	NO. GAMBAR	NO.LBR
		A3-

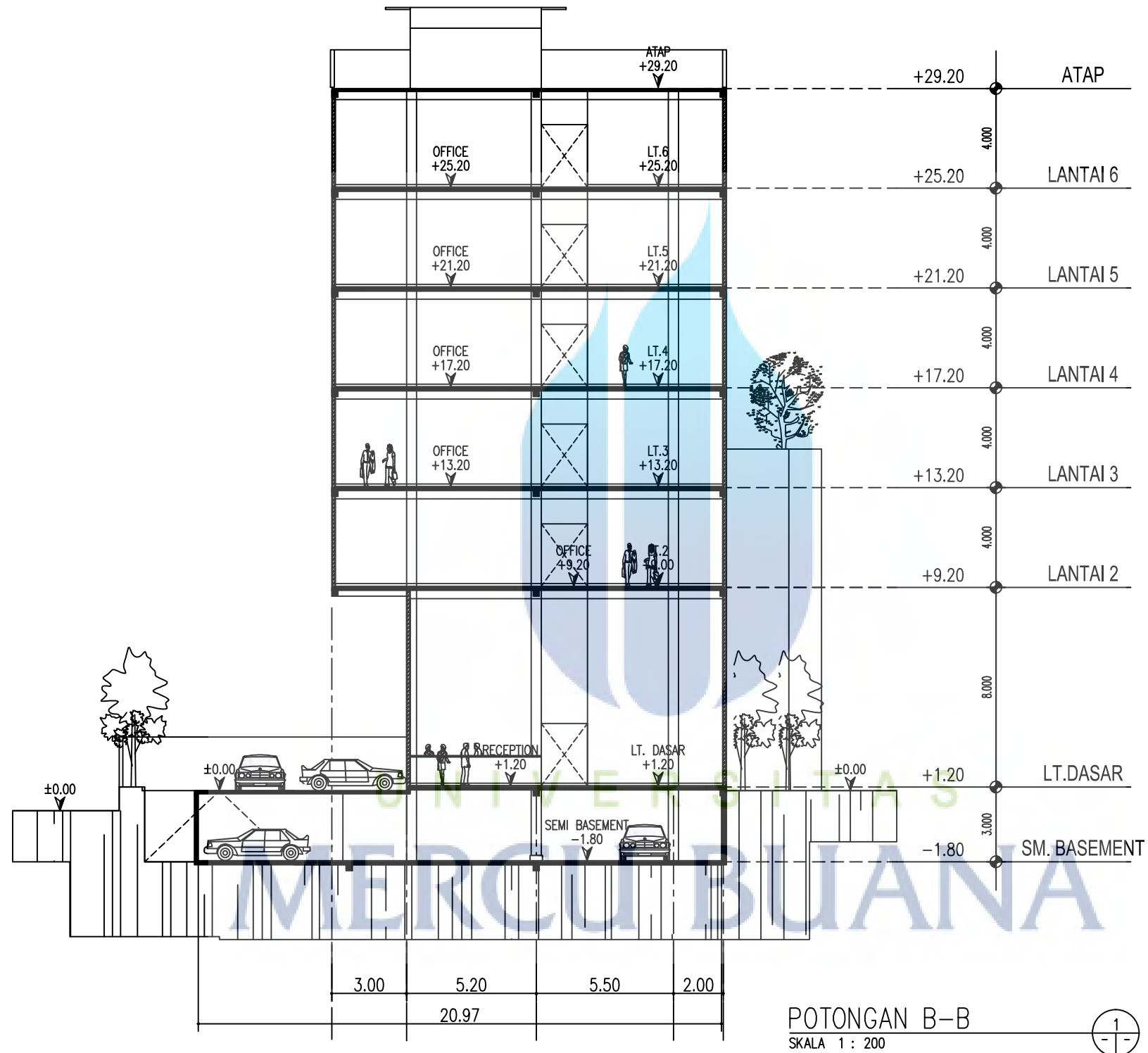

POTONGAN B-B
SKALA 1 : 200

CATATAN

NO	REVISI	TANGGAL PARAF

KEYPLAN

PROYEK

- OFFICE CIDENG -
JL. CIDENG BARAT 46D-47

OWNER/DEVELOPER

PANCA in HOUSE

KONSULTAN ARSITEK

TRENDRAMA
ARCHITECT
BENG_2001@YAHOO.COM

KONSULTAN STRUKTUR

SUYANDRA n PARTNERS
SIBP. 0005/P/KA/DPPB/V-2009
T. 021-65308047, E. suyandra@cbn.net.id

KONSULTAN ME

Mitra Perdana Engineering
Mechanical & Electrical Consultant
Perumahan Prima Kodya Dki/7, 4th Floor, Jakarta Barat - 1538
Phone : 021 5367389
Fax : 021 5367379
E-mail : mitra_perda@indosat.net.id / mpe_mitra@indosat.net.id

KONSULTAN LANSEKAP

KONTRAKTOR

JUDUL GAMBAR

POTONGAN B-B

DIGAMBAR :	DIPERIKSA :	SKALA :
-	-	1 : 1 : 200
TANGGAL :	DISETUJUI :	NO. REVISI :
-	-	-
NO. PROYEK	NO. GAMBAR	NO. LBR
		A3 -